



308 Industrial Park Road
 Starkville, MS 39759 USA Ph:
 (662) 323-9538 FAX: (662) 323-6551

Model AV-14AVQ
Four Bands Vertical Antenna
10, 15, 20, 40 Meter

INSTRUCTION MANUAL

General Description

The Hy-Gain 14AVQ/WB-S is an omnidirectional, self-supporting, vertical radiator that operates in the 10, 15, 20, and 40 meter amateur bands. The system will work against earth ground or a resonant radial system when mounted above ground. You can make your own radial system following the manual, or use the Hy-Gain 14RMQ Radial System Kit available at your Hy-Gain dealer.

The antenna can be used for either Phone or CW with either a ground or roof mount. It can also be tuned to mid-band for use with either Phone or CW. In either case, the SWR bandwidths of the antenna are broad enough that the antenna will operate at an SWR of 2:1 or less from 10 to 40 meters. The 14AVQ/WB-S is supplied with stainless steel hardware and element clamps for all electrical and most mechanical connections.

Theory of Operation

The use of heavy duty "Hy-Q Traps" provides automatic band selection. The Hy-Q Traps are parallel resonant circuits which isolate the various sections of the antenna and give quarter wavelength resonance on all bands. The top hat enhances the broad-band characteristics of the antenna and permits the antenna to be shortened by top loading it.

WARNING

When installing your system, take 'extreme' care to avoid any accidental contact with "power lines" or overhead obstructions. Failure to exercise this care could result in serious or fatal injury.

FOR OUR OVERSEAS CUSTOMERS: The United States used English units of measurements. Please see page 12 of this manual for assistance in identifying the hardware and components supplied with this product.

Specifications

Mechanical

Overall Height.....	18' (5.4 m)
Mast.....	Accepts 1 5/8" (4.1 cm)
Wind Survival	80 mph (129 kmph)
Hardware.....	18-8 stainless steel, except for U-bolts
Element Tubing Clamps	All stainless steel

Electrical

Frequency Coverage.....	40, 20, 15, 10 meter amateur bands
Input Impedance	50 ohms
SWR at Resonance	1.5:1 or less
Power Capabilities	Maximum legal
Lightning Protection.....	DC ground
Input Connector	SO-239

NOTE: If the terminals of the input connector are checked with an ohmmeter, they will show a direct short. This is normal! The matching coil in the antenna base puts the entire system at DC ground, but present a perfect 50 ohm impedance to rf energy

Choosing a Site

The 14AVG/WB-s can be mounted on the ground, on a rooftop or on a mast. When mounting the antenna more than three feet above ground, a resonant radial system must be used, such as Hy-Gain's 14RMQ Radial System Kit. If the antenna is roof mounted and the roof space is too small for a radial system, you can droop the radials over the edge of the roof at almost any angle without seriously changing the performance of the antenna. The radial system must be insulated from the roof and connected to a good ground for lightning protection. See Figure 5.

For best performance, the 14AVQ/VVB-S should be ground-mounted clear of building and other structures. When the antenna is ground-mounted, a radial system is sometimes not needed. In most areas, where soil surface conductivity is poor and a good ground plane is not possible, lay out ground radials to improve the efficiency of your antenna.

Installation of Radials

There is no need to make radials exactly 1/4 wavelength long for the 14AVQ/WB-S. In fact, the only case where you should have 1/4 wavelength radials would be for approximately 90 radials. This differs rather dramatically from the case of the Ground-Plane antenna where resonant radials are installed above ground. Since the radials of a ground-mounted vertical are actually on, if not in, the ground, they are coupled by capacitance or conduction to the ground, thus resonance effects are not important.

Basically, the function of radials is to provide a low-loss return path for ground currents. The reason that short radials are sufficient, when few are used, is that at the perimeter of the circle to which the ground system extends, the radials are sufficiently spread apart. Most of the return currents are already in the ground between the radials rather than in the radials themselves. As more radials are added, the spaces between them are reduced and longer lengths help to provide a path for currents still farther out.

Since the 14AVQ/WB-S is a multi-band, vertical antenna, the radial system should be optimized on the lowest frequency you plan to use. Higher frequencies will benefit equally from the ground system, while lower frequencies will not show as much improvement.

To determine the optimum radial installation for your 14AVQ/WB-S, you must first decide what is the limiting factor for your installation.

1. Cost of radial wires
2. Land available for radials
3. Efficiency of your antenna

Table 1 shows some various ground system configurations. System A is the least costly and the least efficient. System F is the most expensive, takes the most land and is the most efficient.

	A	B	C	D	E	F
Number of Radials	16	24	36	60	90	120
Length of each radial in wavelengths	.1	.125	.15	.2	.25	.4
Spacing of radials in degrees	22.5	15	10	6	4	3
TOTAL length of radial wire installed, in wavelengths	1.6	3	5.4	12	22.5	48
Power gain over antenna with 8' ground rod in average ground, in dB	3	4	4.5	5	5.5	6
Feedpoint impedance in ohms with a 1/4-wave radiating element	52	46	43	40	37	35
Radial end buried	YES	YES	YES	NO	NO	NO

Table 1 **Optimum Ground System Configurations**

Phase Verticals for

Two or more 14AVQ/WB-S antennas may be phased together to produce gain or directivity over one antenna. Refer to the Engineering Report entitled "Amateur Phasing" included with this product.

Assembly and Installation

Before you begin, read the instructions and study the illustrations. Compare the parts against the Parts List.

Decide where to mount your antenna (rooftop or ground) and what mode of transmission you will use (Phone, CW or Mid-Band). Take special notice of the dimensions in Figure 1. The SWR charts will help you decide which dimensions to choose. See Figure 7.

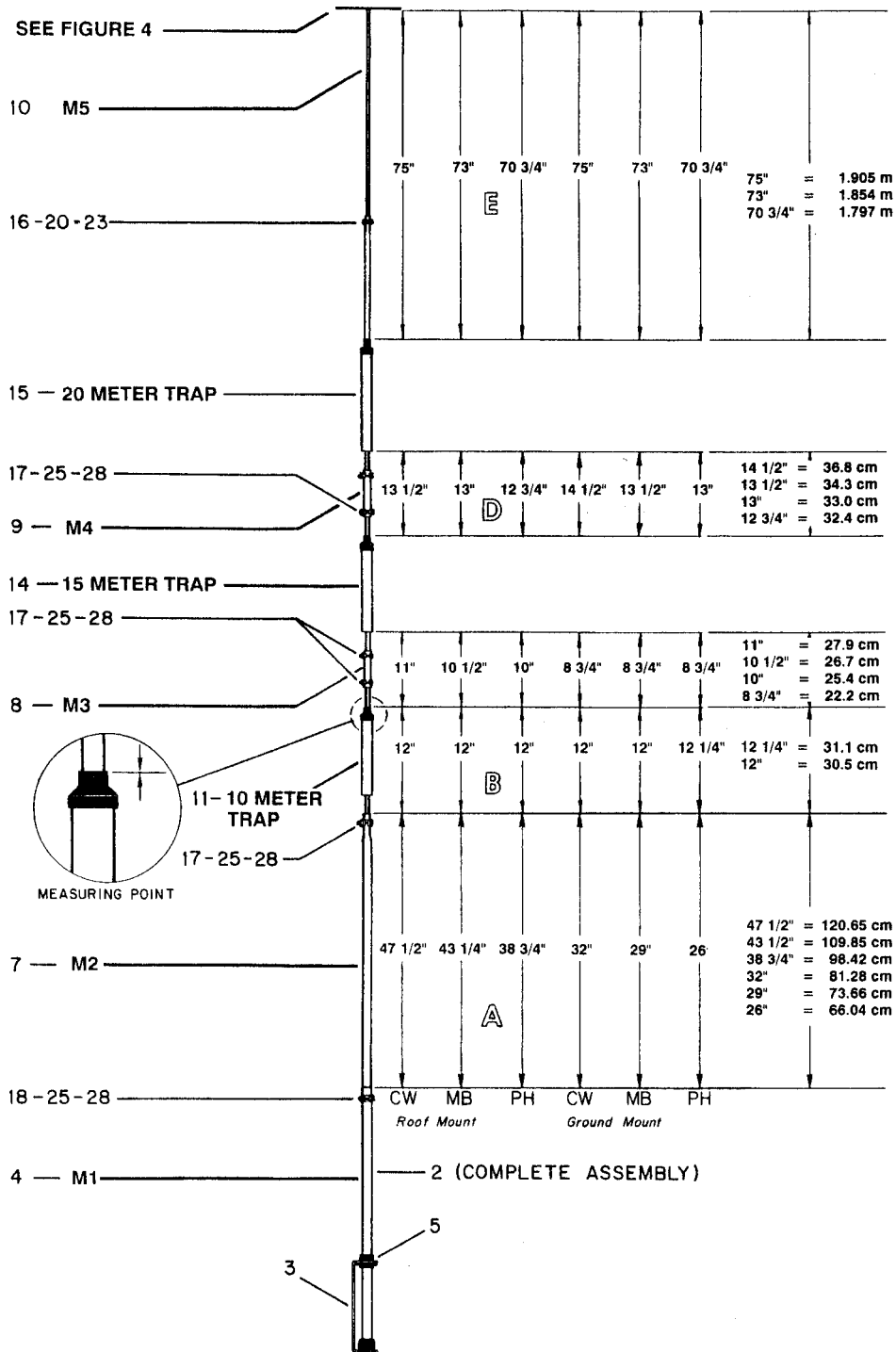

Item No.	Description	Item No.	Description
2	Base Assembly, 14AVQ	11	Trap, 10 meter
4	Tube, M1, 1 1/4" x 48", slotted	14	Trap, 15 meter
5	Insulator, upper	15	Trap, 20 meter
7	Tube, M2, 1 1/8" x 52"	16	Clamp, Tubing, No. 6
8	Tube, M3, 1" x 8"	17	Clamp, Tubing, No. 10
9	Tube, M4, 1" x 6 1/2"	18	Clamp, Tubing, No. 16
10	Tube, M5, 7/16" x 56"		

Figure 1 Antenna Assembly
Dimensions

Tubing

Select the proper size tube clamps as shown in the chart. When installing the clamps, place the clamp near the tube end with the top of the clamp over the slot in the tube as shown in Figure 2.

After adjustment of the tubing lengths, tighten the clamp with a 5/16 inch nut driver, socket, or open end wrench until the tubing will not twist or telescope. DO NOT over-tighten!

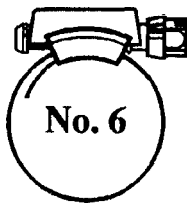
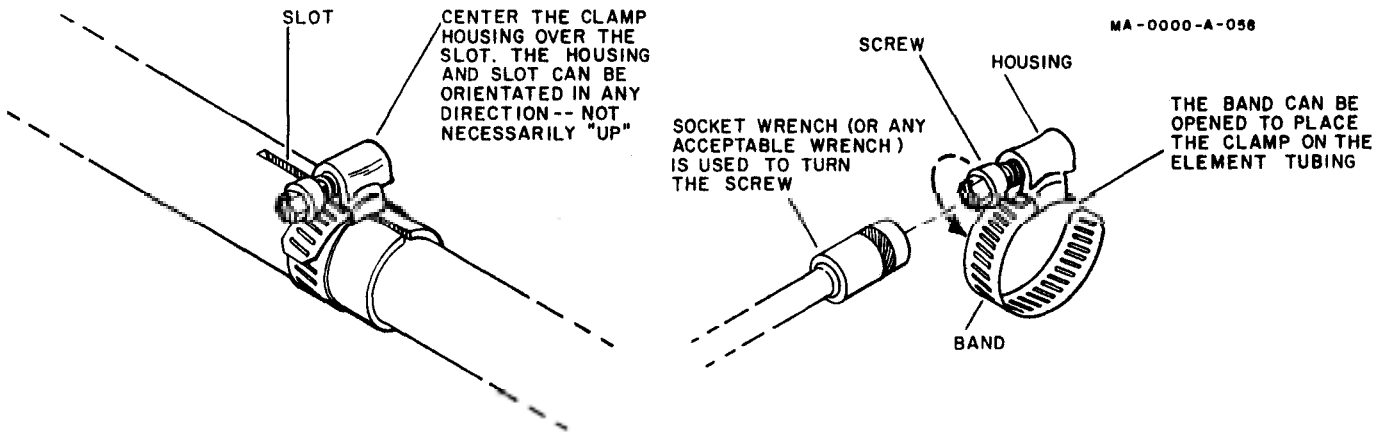

Part No.	Description	Fits Tubing Sizes
358756	Clamp, Size #6 all stainless steel 5/16" hex head screw	1/2 and 3/4"

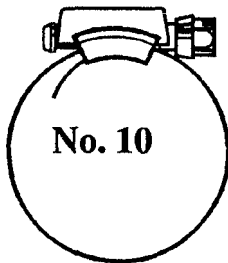

Part No.	Description	Fits Tubing Sizes
358757	Clamp, Size #10 all stainless steel 5/16 hex head screw	1"

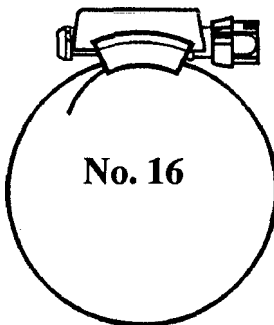

Part No.	Description	Fits Tubing Sizes
358758	Clamp, Size #16 all stainless steel 5/16 hex head screw	1 1/4"

Figure 2 Tubing Clamps

CAUTION

All of the antenna dimensions must be set on the mode chosen - all CW, all mid-band or all phone. Mixing dimensions in an attempt to improve another mode on certain bands will only degrade performance on all bands.

Refer to Figure 1 in assembling the main portion of the antenna.

M1 and M2 Section

Put a #16 tubing clamp (Item No. 18), un-tightened, over the M1 section (Item No. 4)(the base is attached to it already). Slip the 1 1/8" x 52" M2 section (Item No. 7) into the top of the M1 and set the M2 at dimension 'A', as shown in Figure 1. Slide the clamp into place around the top of the M1 and tighten it just enough to keep the M2 from skipping. It will be fully tightened later.

10-Meter Trap

Put an un-tightened #10 Tubing clamp (Item No. 17) over the M2 section, then slip the 10 meter trap (Item No. 11), bottom first, into the M2 section. (There is a plastic cover on the top of all three parts.) Set the trap at dimension "C", as shown in Figure 1. Slip the clamp into place around the top of the M2 section and tighten it just enough to keep the trap from slipping. It will be fully tightened later.

15-Meter Trap and M3 Section Assembly

Place two, un-tightened #10 tubing clamps (Item No. 17) over the 1" x 8" long M3 section (Item No. 8). Slide the M3 section part way over the upper end of the 10-meter trap, then slide the lower end of the 15-meter trap (Item No. 14) into the M3 section. Set dimension "C", as shown in Figure 1, and locate the M3 so that it is equally spaced between the two traps.

Tighten the clamps around the ends of the M3 just enough to keep parts from slipping. They will be fully tightened later.

20-Meter Trap and M4 Section Assembly

Assemble these two parts like you did the M3 and the 15-meter trap. Use two more #10 tubing clamps, the 1" x 6 1/2" long M4 section (Item No. 9) and the 20-meter trap (Item No. 15).

NOTE: There is a threaded metal insert in one end of the M5 section which will accept the #10-24 x 1" bolt (Item No. 20), which will hold the top hat in place. The end with the insert must be at the top.

M5 Section

Put a #6 tubing clamp (Item No. 16), un-tightened, over the swaged end of the 20-meter trap. Slip the 7/16" x 56" long M5 section (Item No. 10) into the swaged end of the trap and set dimension "E", as shown in Figure 1. Slide the clamp in place around the top of the swaged end of the trap tube and tighten it just enough to keep the M5 from slipping. It will be fully tightened later.

Top Hat

Refer to Figure 3, Radial Top Hat Assembly, in assembling the Top Hat

Push a 1/8" caplug (Item No. 19) on the end of each top radial (Item No. 1).

AO-385S-A-007

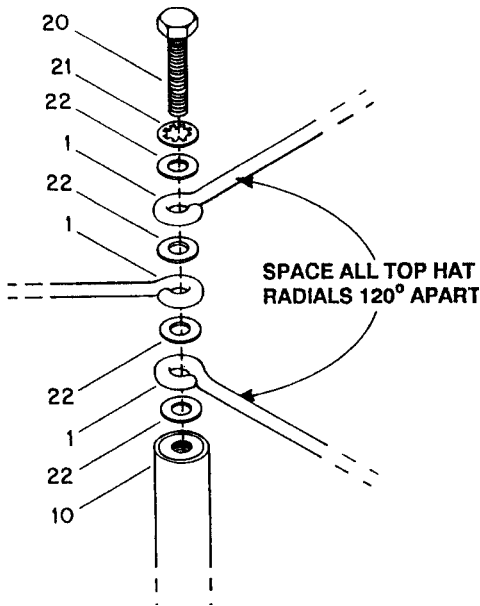

Item No.	Description
1	Radial Top Hat
10	Tube, M5, 7/16" x 56"
20	Bolt, hex head, #10-24 x 1"
21	Lockwasher, internal, #10
22	Flatwasher, #10

Figure 3 Radial Top Hat Assembly

Use the following pieces of hardware to attach the three radial wires on the M5 section. Tighten securely.

Bolt, hex #10-24 x 1" (Item No. 20)1
Flatwashers, #10 (Item No. 22)4
Lockwasher, internal, #10 (Item No. 21)	..1

Recheck all dimensions. Tighten all of the compression clamps securely in place.

WARNING

Installation of this product near power lines is dangerous. For your safety, follow the installation directions.

Installing the Antenna

Refer to the mounting details in Figure 4 and 5 to install the completed antenna.

AO-385S-A-006

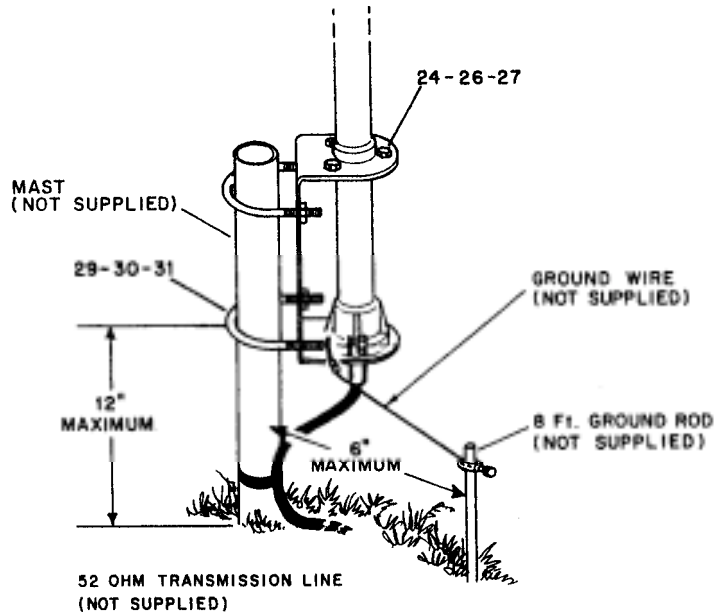

Item No.	Description
24	Bolt, hex head, 1/4" - 20 x 3/4"
26	Lockwasher, internal, 1/4"
27	Nut, hex, 1/4"-20
29	U-Bolt, 5/16" x 1 5/8" x 2 1/4"
30	Lockwasher, split, 5/16"
31	Nut, hex, 5/16"-18

Figure 4 Mounting Assembly

First mount the completed antenna on your mast (not supplied) as shown in Figure 4. Use the two U-bolts, 5/16" nuts and 5/16" lockwashers (Items Nos. 29,31 and 30).

Use three (3) 1/4"-20 x 3/4" bolts, nuts and lockwashers (Item Nos 24, 27 & 26) to attach the insulator to the upper end of the mounting bracket.

If you are roof mounting your antenna, use four (4) sets of 1/4"-20 hardware for the preceding step. Before tightening them, attach two adjacent radials to each set of hardware as shown in Figures 3 and 5. If desired, you may use the four, 33 foot (10.058 m) radial system shown.

NOTE: If your antenna is mounted more than three feet (91.4 cm) above ground, a resonant system must be added for proper operation. The radial system can serve to guy the system if insulators are used at the proper lengths shown.

This system must be grounded for lightning protection. Connect a ground wire to one U-bolt on the antenna base and run it to a buried, 8 foot (250 cm) ground rod by the shortest route.

If you are ground mounting your antenna, install it as shown in Figure 4. You must install an 8 foot (250 cm) ground rod as shown.

CAUTION

Keep the radials out of reach of children or pets. They are HOT with RF proportional to the power of the antenna.

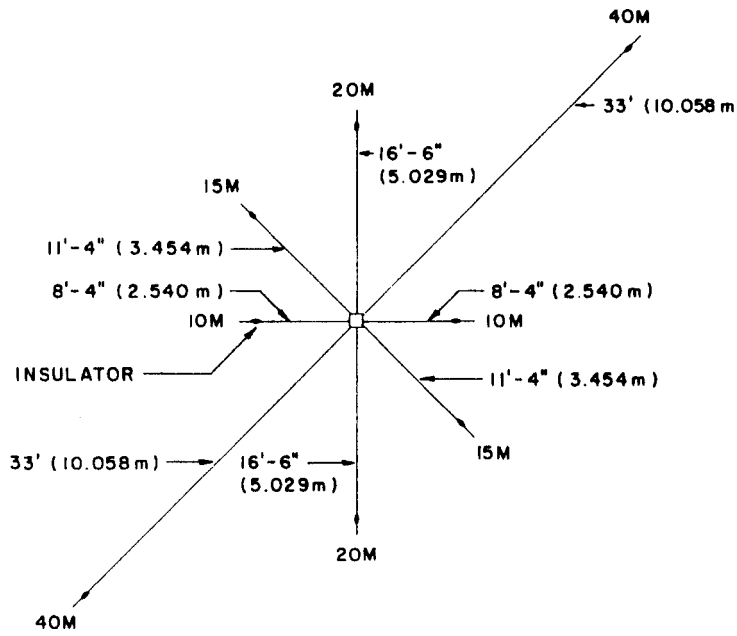

PREFERRED SYSTEM

NOTE: RADIAL DIMENSIONS MEASURED FROM BASE TO INSULATOR.

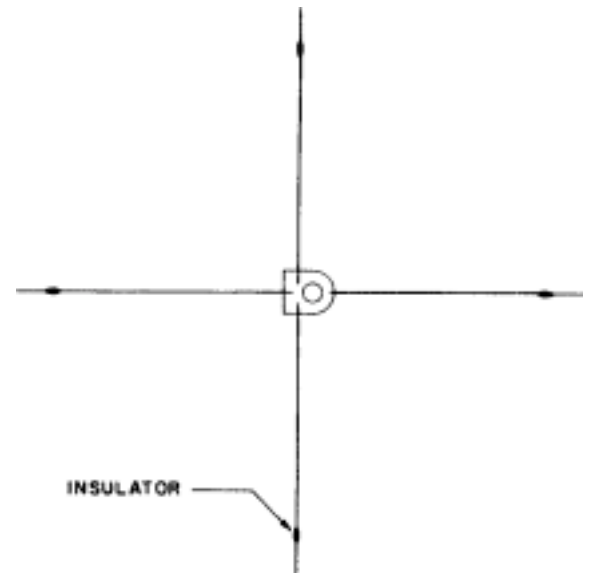
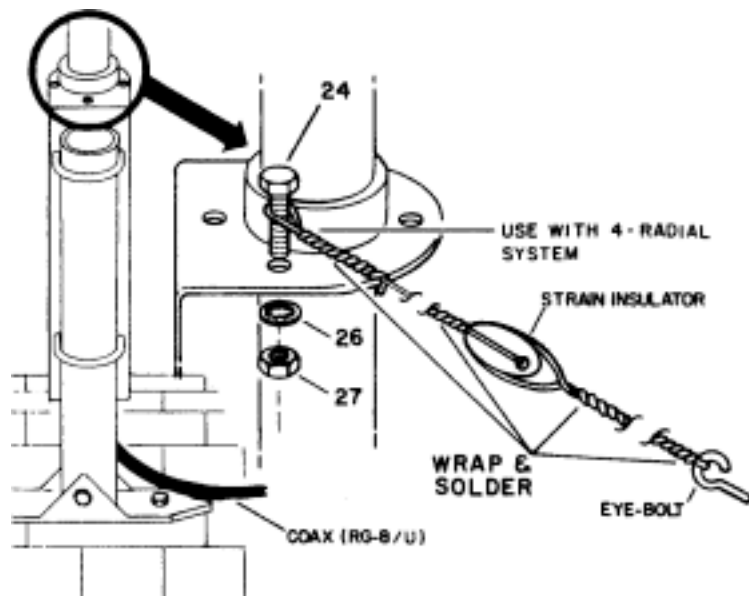
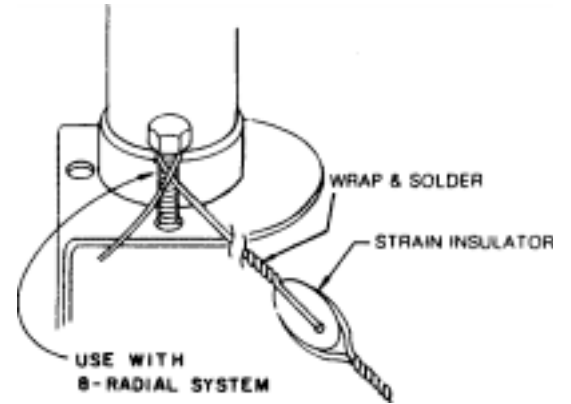

ALTERNATE SYSTEM
ALL RADIALS 33' (10.058 m)
FROM BOLT TO INSULATOR

Item No.	Description
24	Bolt, hex head, 1/3"-20 x 3/4"
26	Lockwasher, internal, 1/4"
27	Nut, hex, 1/4"-20

Figure 5
Guying
Details

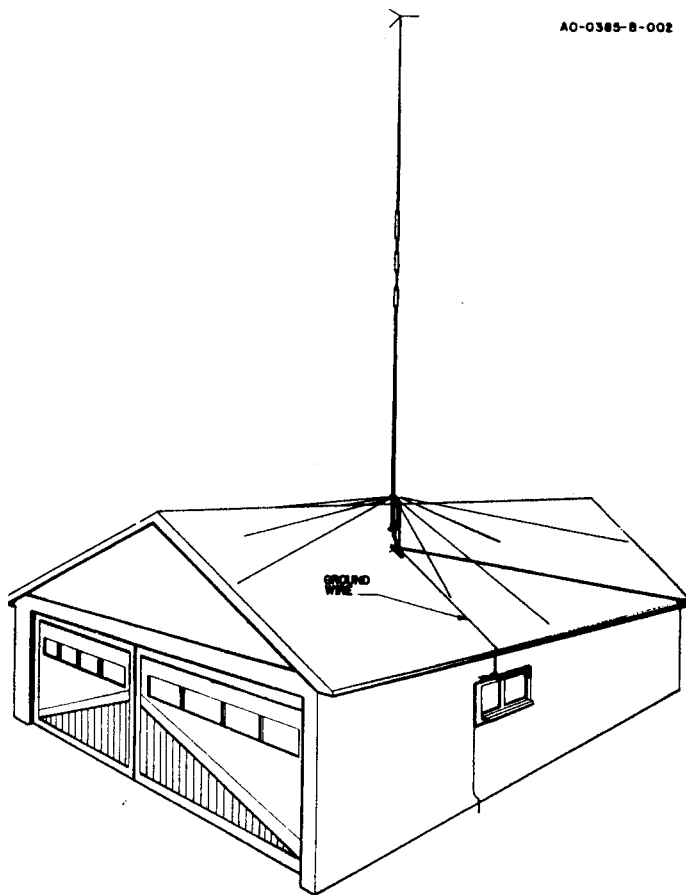

Figure 6 Completed Installation of
14AVO/WB-S

Hooking Up The Antenna

Connect your coax (RG-213/U) to the SO-239 connector at the bottom of the mounting bracket. (Coax not supplied.)

Weather seal the coax connection with Coax-Seal© or an equivalent to prevent moisture from shorting out the connection.

Final Adjustment (Optional Fine Tuning Of Your Installation)

1. The antenna operates progressively from 10 thru 40 meters. Even though you may not be using 10 meters at the present time, 10 meters must be adjusted, because any adjustment made between the base and the first trap automatically changes all of the bands.
2. Because every antenna installation is influenced by the soil conditions and the proximity effect of nearby objects, the dimensions in the manual must be fine tuned to put the antenna VSWR exactly where you want it on each band.
3. Beginning on 10 meters, make a VSWR curve checking the low end, center and high end of the band. This will indicate if the antenna favors the low end or the high end as installed.
 - a. If it favors the low end, shorten the 10-meter adjustment one inch or no more than 1 1/2 inches. Run another VSWR measurement. Now you will have an indication of how far that distance moved the antenna in your location. Make what additional adjustments are indicated by the VSWR curve to put 10 meters exactly on the portion of the band you desire as your center operating frequency.

- b. If the antenna favors the high end, lengthen the dimension correspondingly to move the antenna to a lower frequency as outlined above.
4. Next, repeat this same procedure for 15 meters to put that band on frequency.
5. The same procedure is then used to set up the 20-meter band, as well as the remaining bands available, depending upon the model involved.

6. Most verticals are monopole antennas or half of a dipole. For this reason, the soil conditions, when the antenna is ground mounted, are important as it makes up the other half of the antenna. When you roof mount the antenna, radials must be used as outlined in the assembly instructions, to provide the other half of the antenna.

Lightning Protection

For maximum lightning protection, we recommend the use of a Hy-Gain LA-1 Lightning Arrestor, available from your Hv-

Your antenna is now ready to use.

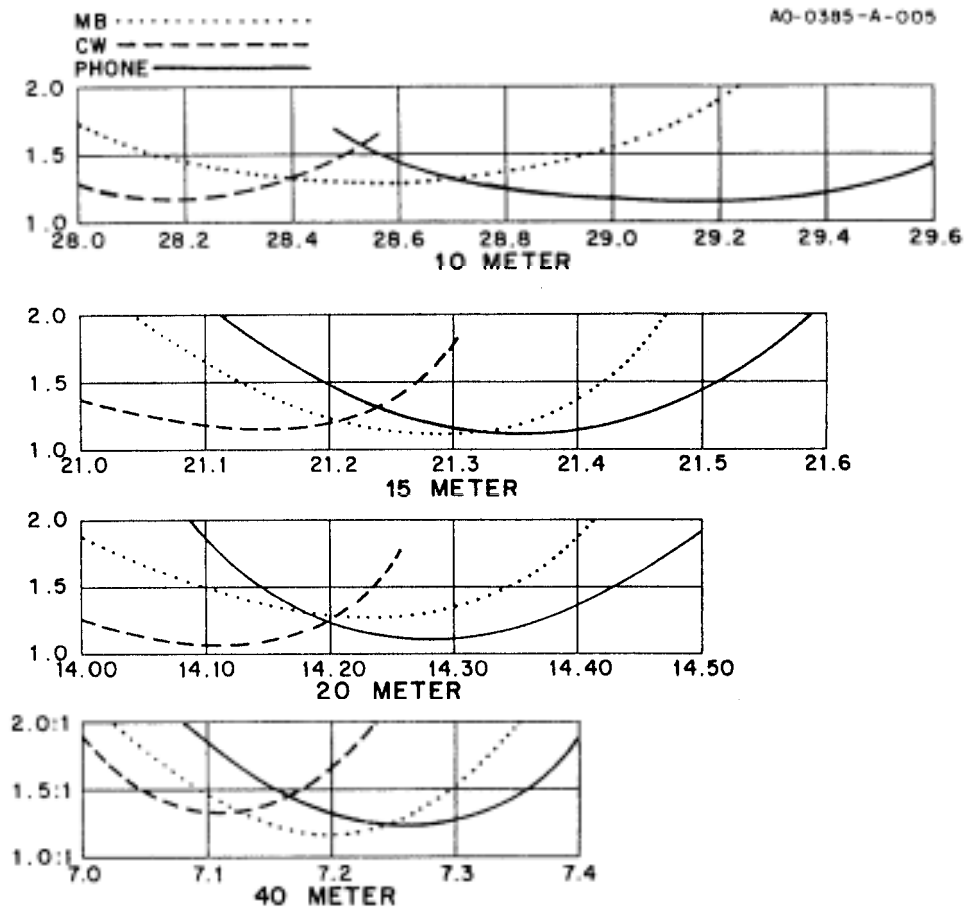

Figure 7
VSWR Curves

PARTS LIST

Item No.	Part No.	Description	Qty
1	173499	Radial Top Hat	3
2	871049	Base Assembly, 14AVQ	1
3		(not used)	
4	190900	Tube, M1, 1 1/4" x 48", slotted	1
5	463056	Insulator, upper	1
6	523057	Screw, hex head, #10-24 x 1"	1
7	190303	Tube, M2, 1 1/8" x 52"	1
8	190603	Tube, M3, 1" x 8"	1
9	190605	Tube, M4, 1" x 6 1/2"	1
10	877157	Tube, M5, 7/16" x 56"	1
11	877132	Trap, 10 Meter	1
12	464723	Trap Cap, 7/8" x 15/8"	1
13	461466	Trap Spacer	4
14	877131	Trap, 15 Meter	1
12	464723	Trap Cap, 7/8" x 15/8"	1
13	461466	Trap Spacer	4
15	877129	Trap, 20 Meter	1
12	464723	Trap Cap, 7/8" x 15/8"	1
13	461466	Trap Spacer	4
	872013	Parts Pack, 385S, Stainless Steel	1
16	358756	Clamp, Tubing No. 6	1
17	358757	Clamp, Tubing No. 10	5
18	358758	Clamp, Tubing No. 16	1
19	455624	Caplug, 1/8" diameter	3
20	504069	Bolt, hex head, # 10-24 x 1"	1
21	565697	Lockwasher, internal, #10	3
22	561165	Flatwasher, #10	4
23	555693	Nut, square, #10-24	1
24	505266	Bolt, hex head, 1/4"-20 x 3/4"	4
25		(Not Used)	
26	562961	Lockwasher, internal, 1/4"	5
27	554099	Nut, hex, 1/4"-20	4
28		(Not Used)	
29	543792	U-bolt, 5/16" x 15/8" x 2 1/4"	2
30	564792	Lockwasher, split 5/16"	4
31	555747	Nut, hex, 5/16"-18	4

Converting English Measurement to Metric

Use this scale to identify lengths of bolts, diameters of tubes, etc.. The English inch (") and foot (') can be converted to centimeters in this way.

$$1 \text{ inch (1")} = 2.54 \text{ cm}$$

$$1 \text{ foot (1')} = 30.48 \text{ cm}$$

Example:



ADDENDUM

AMATEUR PHASING

ENGINEERING REPORT

**PHASED MULTI-BAND
VERTICALS** for ADDITIONAL GAIN and
LOW ANGLE RADIATION

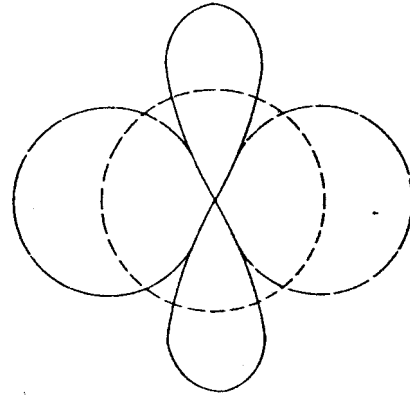

Phased Patterns

INTRODUCTION

The following Hy-Gain verticals are well adapted for the phasing arrangements shown in this report.

MODEL 18HT-S HY-TOWER

The 18HT-S is a multi-band vertical antenna with automatic band selection of 10-80 meters by means of a unique stub decoupling system. The Hy-Tower with a base loading coil operates efficiently on 160 meters. The system is foolproof, fed directly with a single 50 ohm coax. No guys are required for the 24 feet high, self-supporting tower. The top mast extends the height to 50 feet. Two units make an ideal phased array.

MODEL 18AVT/WB-S

The 18AVT/WB-S is a multi-band trap vertical for 10 through 80 meters. It is completely factory **pre-tuned and exhibits an extremely low angle** DX radiation pattern. It is easy to assemble, light weight which one man can install. A single 50 ohm coaxial feedline is required. Two or three 18AVT/WB-S's make an excellent phased array.

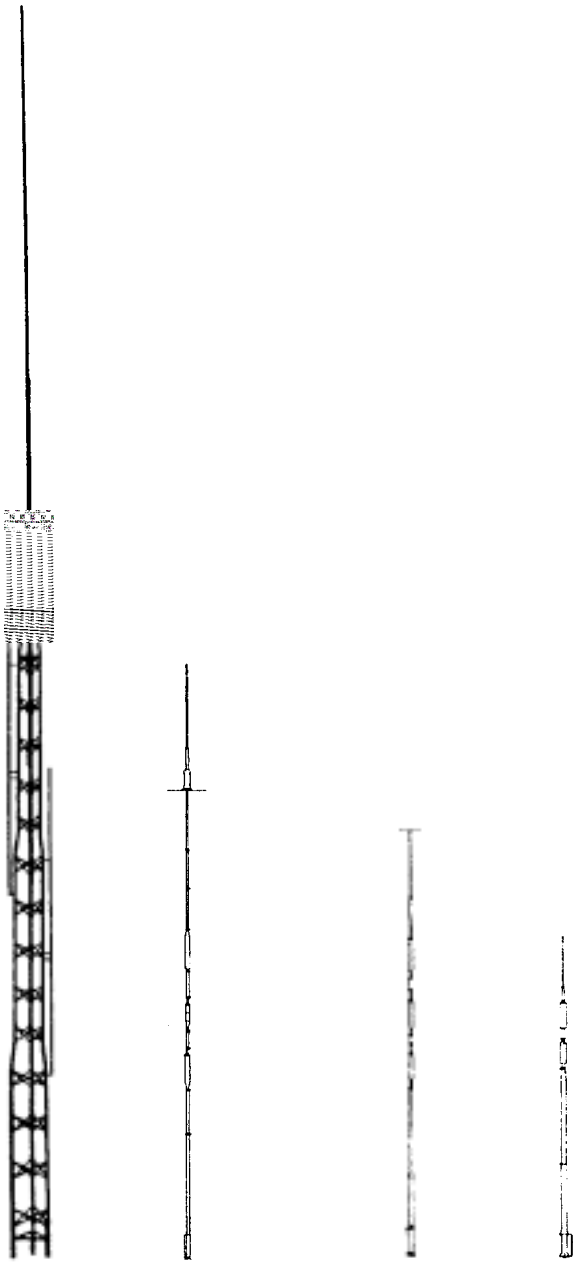

AV-18HT AV-18VS/18AVT AV-14AVQ AV-12AVQ

MODEL 14AVQ/WB-S

The 14AVQ/WB-S is a self supporting multi-band trap vertical for 10 through 40 meters and is completely factory pre-tuned. It is the world's most popular ham antenna with an overall height of 19 feet. The antenna is thoroughly weatherproofed and has a low angle DX radiation pattern. It may be ground mounted or installed on "Roof Top" with a radial system.

MODEL 12AVQ

The 12AVQ is a self supporting 13 1/2 foot multi-band trap vertical for 10, 15 and 20 meters. Completely factory pre-tuned with SWR of 2:1 or less with a low angle DX radiation pattern. The antenna has a new fiberglass impregnated styron base insulator. It may be ground mounted with earth acting as the "image antenna" or installed on the roof using a radial system.

DESCRIPTION

Increased activity on 80 and 40 meters has created a need for an antenna with power gain and directivity. Doublet and long wire antennas are no longer effective due to increased QRM. At these low frequencies, the radiation system must be lengthy and height above ground is extremely important to obtain the "low" angle of radiation needed for DX.

Part 1 - SINGLE BAND

BI-DIRECTIONAL ARRAY (Four Quadrants)

THEORY' OF OPERATION

Two identical vertical antennas can be installed as a phased array. When excited by RF energy, gain is achieved by control of the directional pattern. This direction pattern control results in added gain by sharpening lobe patterns and concentrating the radiated energy at very low angles. Signal flutter is reduced and reception is vastly improved.

Beams are excellent, but require a large supporting tower and "hefty" rotating system. Inverted V dipoles and slopers require a large tower and plenty of property.

The vertical "phased array", the answer for "DX" on these frequencies combine gain, directivity and low angle radiation, the three most important DX factors in a communication installation. The vertical is well known for its low angle characteristics. When you combine two identical verticals, properly spaced and phased, the resultant is a concentrated low angle of energy and a power gain. These antennas can be so arranged to give a definite effect on either one or two favorite bands or all band coverage with some pattern compromise and slight loss of gain.

The following data was experimentally derived on the Telex/Hy-Gain test range. Due to the many factors that vary and influence the performance of an antenna, such as grounding and close proximity of surrounding objects, etc., Telex/Hy-Gain cannot guarantee an installation to perform or exhibit the same characteristics as outlined in this report. However, many Amateurs are now successfully using these arrangements. Commercial broadcast stations have been using a similar phasing arrangement for years.

Phased arrays will reduce installation height requirements and still maintain low angle radiation.

Most effective spacing for a bi-directional array is 1/2 wave length. When two verticals are excited in phase the radiation is broadside to the plane of the verticals, offering substantial gain and bi-directional characteristics. Side nulls offer excellent signal cancellation to the undesired direction.

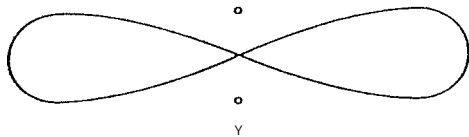

When excited "out of phase" these same verticals can be made to give an "end fire" or bi-directional pattern in the opposite direction through the plane of the verticals. This then nulls out signals in the opposite directions. More gain is exhibited by the broadside pattern over the "end fire" arrangement, but the "end fire" arrangement offers a wider frontal pattern.

Both arrangements offer an excellent advantage over a single vertical since either phasing combination exhibits noticeable signal gain with side attenuation of undesired signals. This added gain and low angle vertical directivity is the advantage of the phased array.

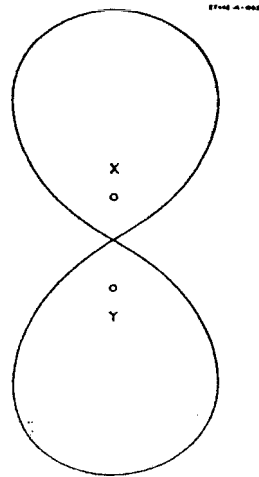

"ENDFIRE" GAIN 23 dB

Phased verticals may be spaced either one quarter wave or one half wave depending upon gain and directional characteristics. The nulls of the phased array are extremely sharp and very pronounced. Typical arrangements of phased arrays and their electrical specifications are illustrated below.

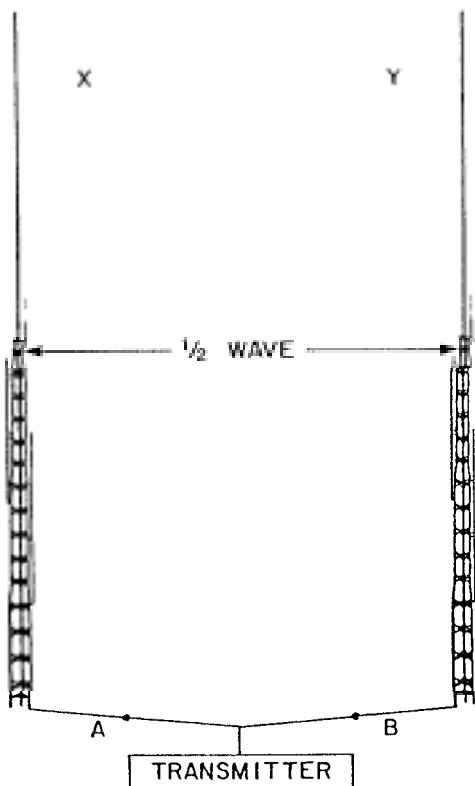

When feedline "A" is the same length as feedline "B" the currents arrive at the base of each antenna at the same time, giving the "inphase" broadside pattern.

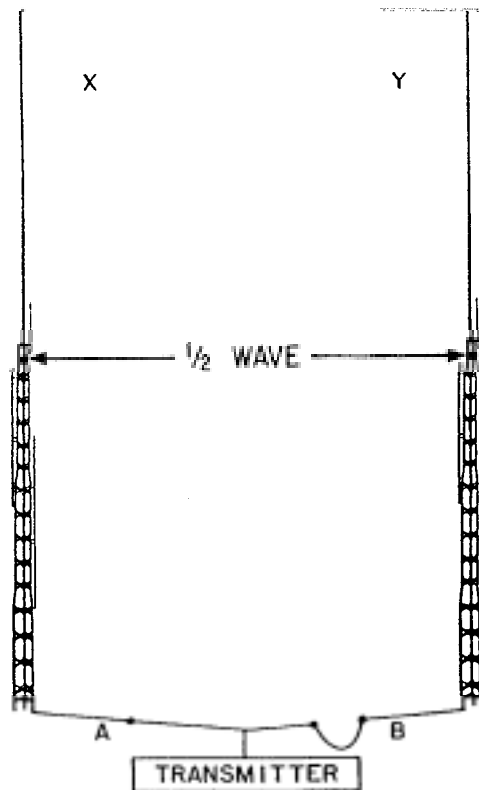

When feedline "A" is 1/2" wave length shorter than feedline "B" the current arrives at antenna "X" 1/2 wave length sooner (180 degrees) than at antenna "Y" giving the "out of phase" end fire pattern.

Figure 1

SPECIFICATIONS

	Broadside	End Fire
Pattern width, half power points	60 degrees	80 degrees
Gain over single vertical	3.86 dB	2.3 dB
Side attenuation	30 dB	20 dB
Impedance	50 Ohms	50 Ohms
Directional characteristics	Bi-Directional	Bi-Directional

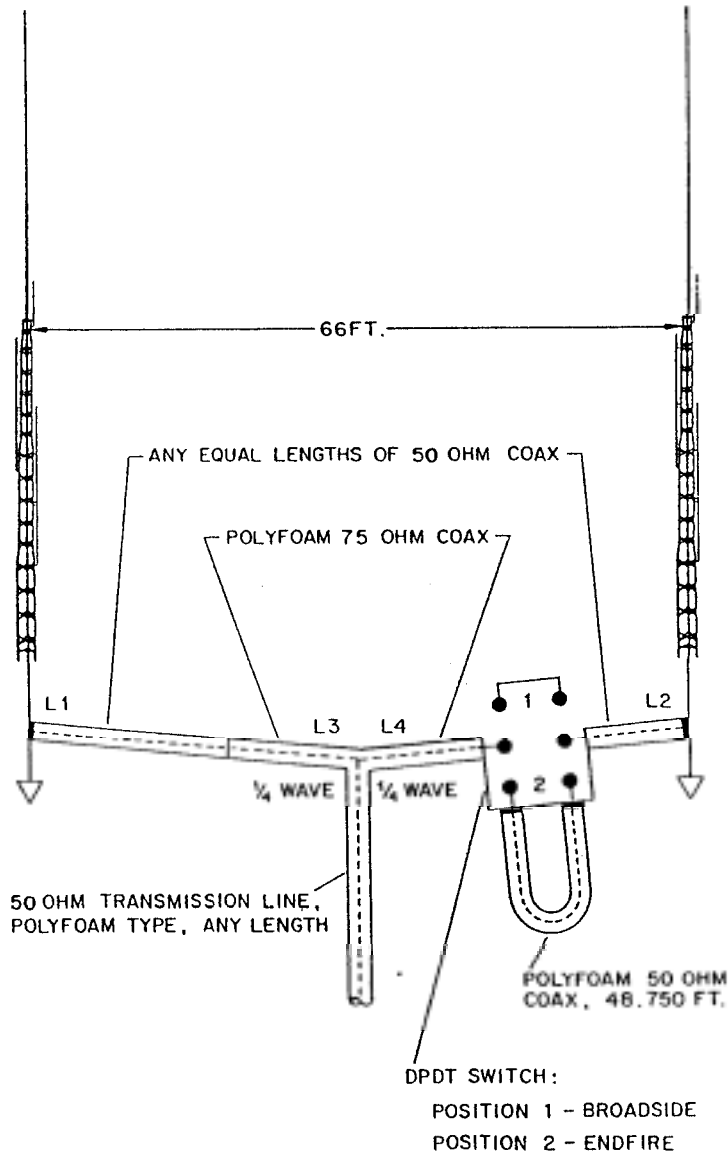
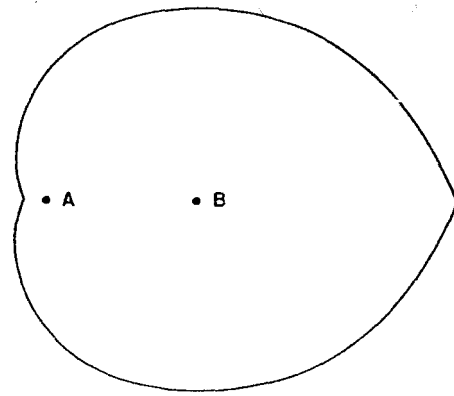

Figure 2
 Typical Installation Phased (2) 18 HT 40 Meters
 7200 KHz Design Frequency

CARDIOID ARRAY (Uni-directional)

When two or three identical verticals are excited directly and fed 90 degrees out of phase with a spacing of $1/4$ wave length, a cardioid pattern results. This pattern may be switched in either direction. By inserting a $1/4$ wave length delay line the antenna will "fire" or be directive to that particular element. ∴



TWO VERTICALS

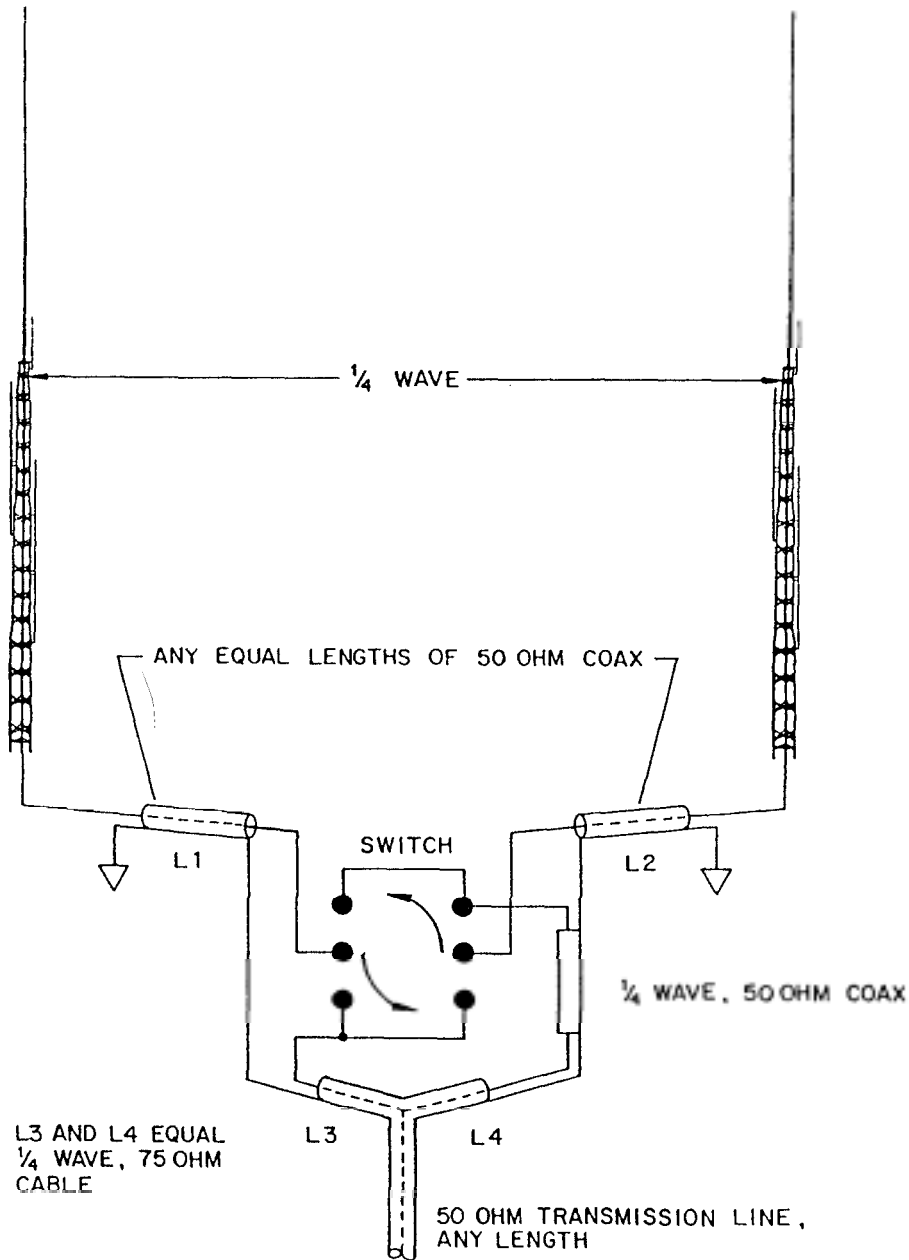
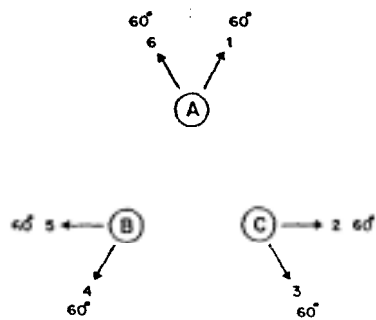

Figure 3
Cardioid-Unidirectional With Two Selectable Directions

The beam pattern for two 1/4 wave length verticals will be approximately 120 degrees. An arrangement of three switchable verticals gives a 60 degree pattern in six selectable directions.



TOP VIEW - 3 VERTICALS

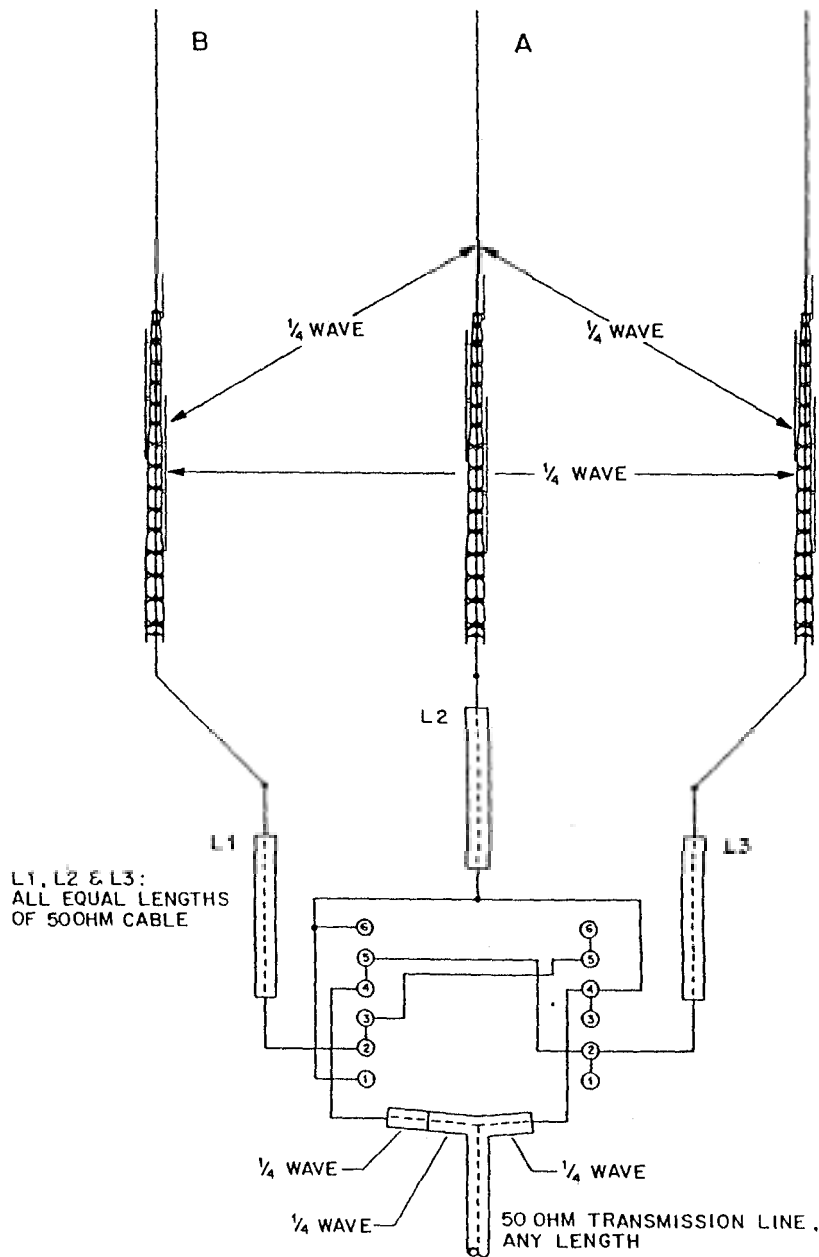

Figure 4
360 Cardioid Arrangement

ELECTRICAL SPECIFICATIONS:

	Two Phased Verticals	Three Phased Verticals
Pattern Width, half power points	120 degrees	60 degrees
Gain over single vertical	4.5 dB	4.5 dB
Side attenuation	20 dB	20 dB
Rear attenuation	30 dB	30 dB
Impedance	50 Ohms	50 Ohms
Directional Characteristics	Uni-directional	Uni-directional

VSWR: Exceptionally low SWR is present with a phased array. If phasing lines are correctly measured and the terminal impedance of each antenna is very close to 50 Ohms: Typical SWR: Broadside 1.2:1, Endfire 1.4:1, Cardioid 1.2:1.

P H A S I N G L I N E S :

The 1/4 and 1/2 wave transformers, identified as L3, L4 and L5 are calculated from the following formula:

$$\text{1/4 wave} = \frac{246000 \times \text{vel. factor} - \text{reg. coax.}}{\text{frequency (in KHz)}} \times 0.66$$

EXAMPLE:

$$\begin{aligned} \text{1/4 wave at 7200 KHz} &= 246000 / 7200 = 34.16 \\ &\quad \times .75 \\ &= 25.62 \end{aligned}$$

1/4 wave = 25.62 ft.

PART 2 - MULTI-BAND OPERATION

M U L T I - B A N D I N G

Multi-banding is easily accomplished by choice spacing two identical verticals. (refer to charts A,B, and C and associated Figures 1 through 5) Switchable 1/4 wave length and 1/2 wave length phasing cables must be employed for each band. These cables can be placed in the station in any suitable fashion along with a manual switching arrangement or relay system.

RADIATION PATTERN:

Consideration must be given to the fact that 1/2 wave spacing (optional) is ideal for phasing. When multi-banding with close and wide spacing, compromise radiation patterns must be expected. In most cases a choice spacing serves 3 bands most effectively with good directional characteristics, added gain and low angle performance.

OPTIONAL SPACING

Various antenna spacings may be selected from charts A, B, and C, for single band, duo band or multi-band arrangements. Associated radiation patterns for a specific spacing is shown in Figures 1 through 5 for each band.

If the $3/4$ wave length patterns are not desirable, a single vertical only can be switched in use to obtain an omni-directional pattern.

INSTALLATION

The vertical antenna requires a minimum amount of space. Ground mounted or elevated arrays are easily installed.

Antenna placement and orientation is a most important factor when planning maximum effectiveness in desired directions. Each vertical should be installed in the clear relatively free of surrounding objects in order to maintain its design 50 Ohm terminal impedance.

Each antenna must be mounted at the same height on or above ground and be so arranged according to their radiation pattern to offer desired directivity.

The phased array is primarily designed for long range and DX communications. In cases where close and medium distance contacts are hampered by the array's low angle characteristics and a higher angle is required, switching arrangements can select one vertical for this coverage.

SWITCHES & CONNECTORS

Low loss constant impedance type coaxial switches and connectors should be used when splicing phasing lines. B&W multi-position, single or multi-gang coaxial switches with Amphenol coaxial cable and "T" connectors are recommended.

FIELD TESTS

Actual field tests comparing one vertical to the phased array results in doubling the receiver sensitivity and offering up to 12 dB of signal increase. An attenuation of up to 30 dB is noticeable on the phased verticals with half wave spacing. With quarter wave spacing, up to 20 dB cardioid, and 30 dB front-to-back attenuation can be obtained.

"End Fire" directivity offers a larger area of radiation at slightly reduced gain as compared to the broadside arrangement. The "broadside" arrangement is recommended for communications at greater distances whereas the "endfire" arrangement would be so arranged to cover a larger area of communications. Special attention to the coax phasing line lengths and their proper placement is of utmost importance.

- A. 80 meter bi-directional pattern (all SW positions 3) refer to Figure 1, Part 2 "Radiation Patterns"

NOTE: Due to close electrical spacing (1/4 wave) on 80 meters for Broadside (position 1) and Endfire (position 2) the SVWR may be somewhat higher than 1/2 wave spacing. SW3 selects direction

- B. 40 meters all switches in position 1 selects Bi-Directional patterns. Use SW2 for broadside (position 1) 1) Endfire (position 2).

- C. All switches in position 2 selects cardioid pattern. SW4 selects direction of cardioid pattern.

NOTE: All connecting lines are exaggerated in length. These lines must be direct and short as with any coax hook-up practice.

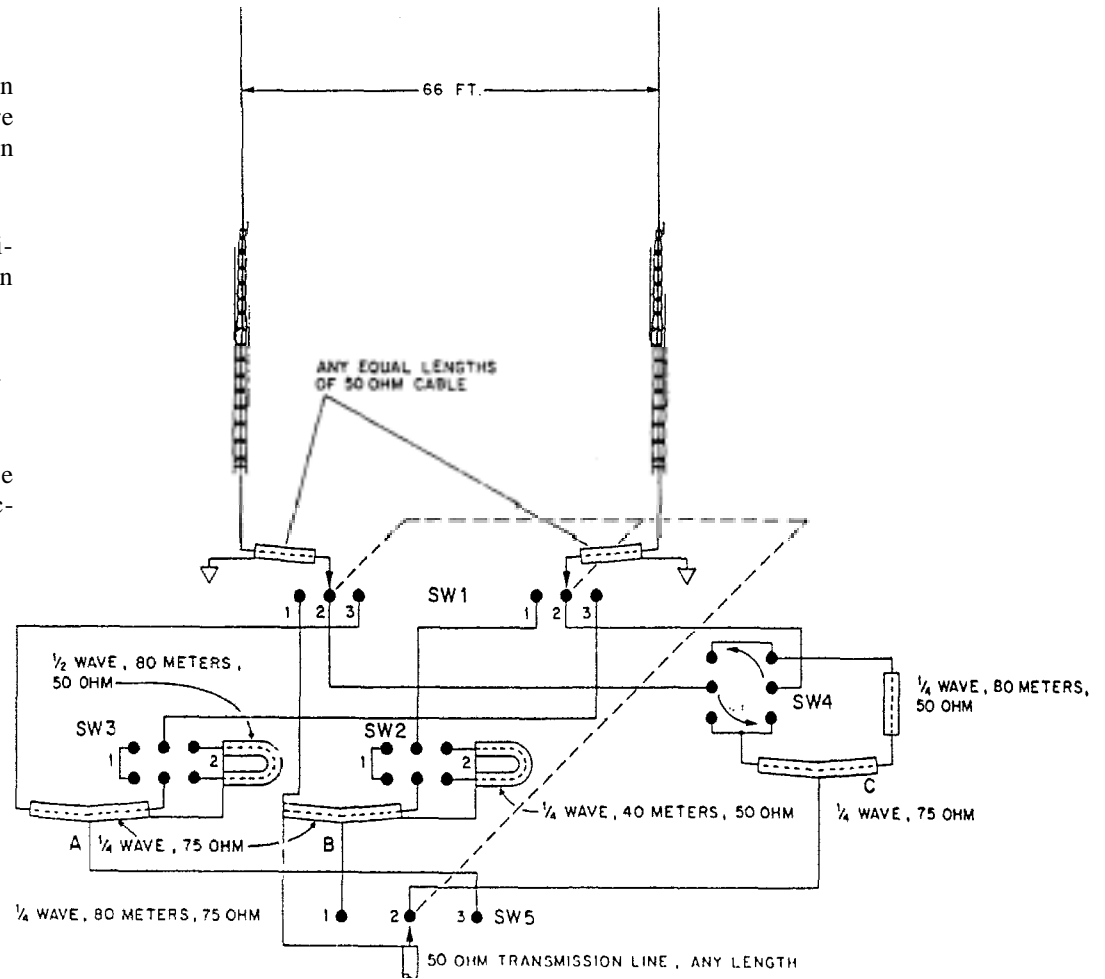
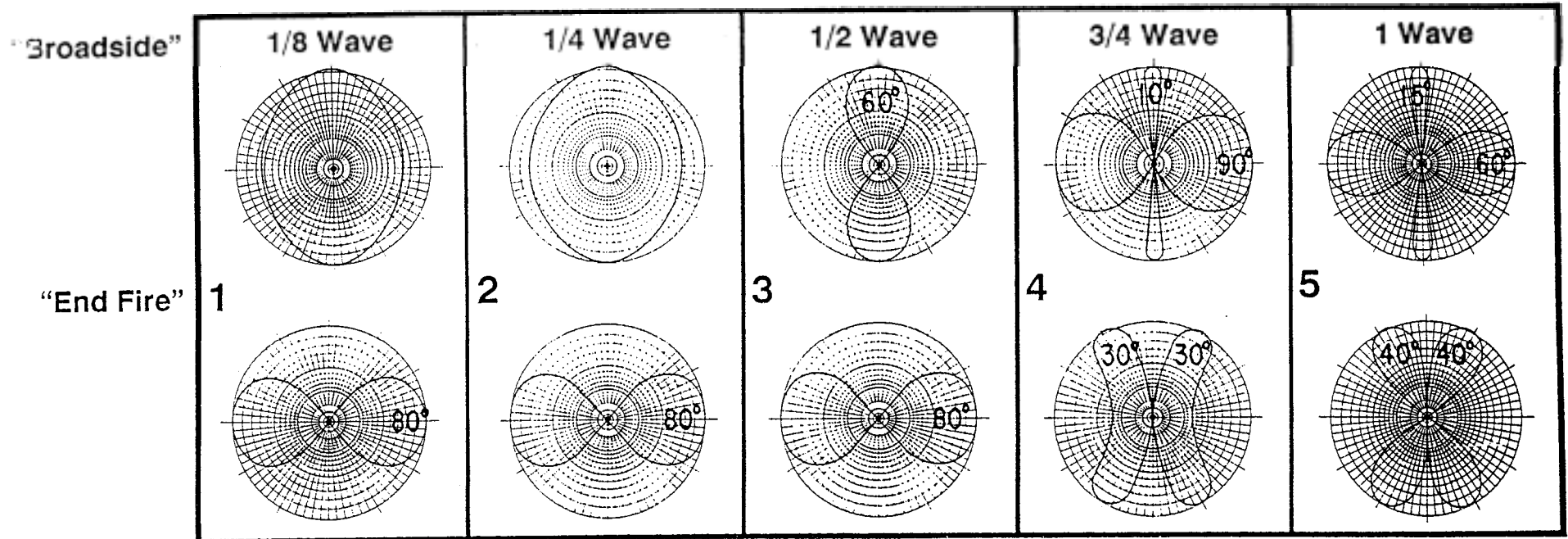

Figure 5
 Typical installation (2) 18HT-S Phased for 80 and 40 Meters Selectable Broadside and Endfire Patters on 40 Meters Selectable Broadside and Endfire Patterns on 80 Meters Selectable 2 Directions Cardioid on 80 Meters



PATTERN CHART
Single Band Arrangement

Spacing

A	125'			80		
	66'			40		
	33'			20		
Two Band Arrangement						
B	66'		80	40		
	33'		40	20		
	16'		15	10		
Multi-band Arrangement						
C	33'	80	40	20	15	10
	66'		80	40	20	

Note: Corralate Patterns to spacing used in installation

Figure 6
Radiation Patterns - Typical Spacing For Broadside And Endfire Arrangements