

MFJ

***Legal Limit IntelliTuner™
Remote Automatic Antenna Tuner
MFJ-998RT***

INSTRUCTION MANUAL

CAUTION: Read All Instructions Before Operating Equipment

MFJ ENTERPRISES, INC.

300 Industrial Park Road
Starkville, MS 39759 USA
Tel: 662-323-5869 Fax: 662-323-6551

Table of Contents

| | |
|------------------------------|-----------|
| THE BASICS | 1 |
| Introduction | 1 |
| Features | 2 |
| Specifications | 2 |
| FAST START | 3 |
| INSTALLATION | 4 |
| OPERATION | 5 |
| INTERNAL CONTROLS | 6 |
| Control Panel | 6 |
| THE MENUS | 9 |
| Main Mode Menus | 9 |
| Digital Wattmeter Menu | 9 |
| Power Bar Meter Menu | 9 |
| L-Network Menu | 10 |
| Tuner Indicators | 10 |
| Setup Mode Menus | 13 |
| Target SWR Menu | 13 |
| Auto Tune SWR Menu | 13 |
| Amp Bypass SWR Menu | 13 |
| Meter Range Menu | 13 |
| Peak Hold Menu | 13 |
| Memory Menu | 13 |
| IntelliTune™ Menu | 14 |
| SWR Beep Menu | 14 |
| Beep Menu | 14 |
| Refresh Menu | 14 |
| Radio Interface Menu | 15 |
| LC Limit Menu | 15 |
| Setup Operation | 15 |
| Manual Tuning | 15 |
| Morse Code and Beeps | 16 |
| Transceiver Foldback Circuit | 16 |
| Grounding Hints | 17 |
| Antenna System Hints | 17 |

| | |
|-------------------------------|-----------|
| Location | 17 |
| Matching Problems | 17 |
| APPENDICES | 19 |
| POWER-ON OPERATIONS | 19 |
| Resetting the Tuner | 19 |
| Factory Defaults | 19 |
| Factory Default Reset | 20 |
| Total Reset | 20 |
| Disable Radio Interface | 20 |
| Delete Entire Antenna Memory | 20 |
| Delete Antenna Memory Bank | 20 |
| Self Test | 20 |
| Power-Down Circuit Test | 21 |
| Relay Test | 22 |
| SWR Bridge Calibration | 22 |
| Frequency Counter Calibration | 22 |
| List of Accessories | 23 |
| FULL 12-MONTH WARRANTY | 24 |

DISCLAIMER

Information in this manual is designed for user purposes only and is not intended to supersede information contained in customer regulations, technical manuals/documents, positional handbooks, or other official publications. The copy of this manual provided to the customer will not be updated to reflect current data.

Customers using this manual should report errors or omissions, recommendations for improvements, or other comments to:

MFJ Enterprises,
300 Industrial Park Road,
Starkville, MS 39759.
Phone: (662) 323-5869
FAX: (662) 323-6551.
Business hours:
M-F 8:00 AM-4:30 PM CST.

The Basics

Introduction

The MFJ-998RT *IntelliTuner*™ is a comprehensive Full Legal Limit remote automatic antenna tuning unit .

The MFJ-998RT lets you rapidly tune almost any unbalanced or single-wire antenna automatically. Balanced feedlines may be used with an MFJ-912 1.5 kW 4:1 balun connected to the MFJ-998RT antenna output.

MFJ's exclusive *InstantRecall*™, *IntelliTune*™ and *AdaptiveSearch*™ algorithms give you fast automatic tuning with more than 20,000 non-volatile *VirtualAntenna*™ memories. Each of the two antenna banks has four banks of memory; and each memory bank has over 2500 non-volatile memories for tuner settings. The banks allow you to save settings for several antennas giving you the flexibility to move the a tuner between antennas or move to different locations without losing the old settings.

The tuner includes a highly efficient switched-L network with wide matching capability, 1.8 to 30 MHz coverage, backlit LCD display, and heavy-duty 16 amp/1000 volt relays. It is rated at 1500 watts SSB/CW and will match impedances from 12 to 1600 ohms (SWR up to 32:1).

A maximum of 256 values of inductance and 256 values of input capacitance or 64 values of output capacitance are available. This provides a total of 81,920 L/C tuning combinations. The nominal tuning ranges are 0 to 24 μ H and 0 to 3900 pF. And once a match is found, the matching network values can be displayed so you may design your own fixed matching network if desired.

Like all MFJ *IntelliTuners*™, the MFJ-998RT learns and remembers. When you transmit, it automatically adjusts for minimum SWR and remembers the frequency and tuner settings, safely stored in non-volatile memory. The next time you operate on that frequency (or close to it) and antenna, these tuner settings are instantly restored and you're ready to operate in milliseconds.

When you key your transmitter, MFJ's *InstantRecall*™ checks its memory to see if you have operated on that frequency before. If so, tuning is instantaneous and you're ready to operate. If not, MFJ's *IntelliTune*™ algorithm (based on MFJ's famous SWR Analyzer technology) kicks in. It measures the complex impedance of your antenna. Next it calculates the components needed and instantly snaps them in. Finally, it fine-tunes to minimize SWR, and you're ready to operate--all in a fraction of a second.

If the antenna impedance is not within the tuner's measurement range, MFJ's *AdaptiveSearch*™ algorithm goes into action. Frequency is measured and relevant components values are determined. Only those values are searched for fast tuning. If it still cannot find a match, the search is performed again using a different search pattern. The target SWR can be set at 1.0 through 2.0. The minimum power to tune is approximately five watts. The tuners enter a "sleep" mode when idle and when no transmit signal is present, turning off the microprocessor clock to avoid the generation of spurious signals.

Features

- Automatically matches antennas from 12 to 1600 ohms impedance (SWR up to 32:1)
- Handles 1500 watts SSB/CW
- Tune in less than 20 seconds, usually less than 5 seconds
- Over 20,000 non-volatile memories for tuner settings
- Eight memory banks with over 2500 memories per bank
- Highly efficient switched-L network matching circuit
- 1.8 to 30 MHz continuous frequency coverage
- Adjustable target SWR from 1.0 to 2.0
- Adjustable SWR threshold from 0.5 to 1.5
- Multifunction backlit LCD display with contrast control for testing and setup
- Numeric readings for SWR, forward and reflected power for testing and setup
- Bar meters for SWR, forward and reflected power with range options for testing and setup
- Audio SWR meter for testing and setup
- Built-in frequency counter for testing and setup
- Direct read-out of matching L/C values available after tuning for testing and setup

Specifications

- Impedance matching range: 12 to 1600 ohms
- SWR matching range: up to 4:1 for < 50 ohms and up to 32:1 for > 50 ohms
- Minimum power for tuning: 5 watts
- Maximum power while tuning: 100 watts with foldback, 20 watts without foldback
- RF power limit: 1500 watts SSB/CW
- Frequency range: 1.8 to 30 MHz continuous coverage
- Frequency counter accuracy: ± 1 kHz across HF bands
- Capacitance range: 0 to 3926 pF nominal (256 values) on input side 0 to 976 pF nominal (64 values) on output side
- Inductance range: 0 to 24.28 μ H nominal (256 values)
- Relay rating: 16 amp 1000 volts
- Relay electrical life: 100,000 operations
- Relay mechanical life: 10 million operations
- Memory endurance: 1 million erase/write cycles
- Memory data retention: > 200 years
- Power requirements: 12 - 15 volts DC, 2.1 \times 5.5 mm coaxial plug, center pin positive
- Current consumption: 1.4 amps or less
- Dimensions (approx.): 13 $\frac{3}{4}$ \times 6 $\frac{1}{4}$ \times 18 in. (350 \times 159 \times 457 mm) (width/height/depth) including connectors
- Weight (approx.): 9 lb. 8 oz. (4.3 kg)
- Operating Temperature -40 to +160 degrees F

† Specifications and design are subject to change without notice.

Fast Start

WARNING

- Never operate the tuner with its cover removed. Contact with the components inside the tuner while transmitting can result in painful RF burns.
- Locate the tuner so that the terminals are not accessible during operation. The single wire connection may have high voltage while transmitting.
- Disconnect all antennas from the tuner during lightning storms.
- Always tune with low power (about 10 watts). Apply maximum power only after tuning up.
- Never exceed tuner specifications.
- Do not transmit with a high SWR for extended periods of time.

Connect the MFJ-998RT to the transceiver, the amplifier, and the antenna as shown in Figure 1 and per the following directions:

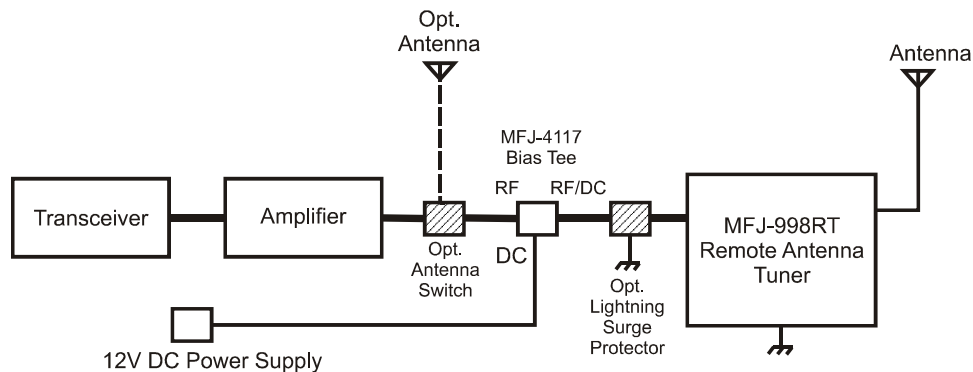

Figure 1 Basic Setup

1. Connect your transceiver or amplifier (if used) output to the MFJ-4117 BIAS TEE RF connector using a 50-ohm coaxial cable.
2. Connect the MFJ-4117 BIAS TEE to a 12-15 VDC voltage source capable of supplying at least 1.4 amps. The center pin on the power connector is positive.
3. Connect the MFJ-4117 BIAS TEE RF/DC output to the TRANSMITTER connector on the MFJ-998RT
4. Connect your coax-fed antenna to the ANTENNA connector using a 50-ohm coaxial cable, or connect your random wire to the WIRE binding post.

WARNING

Do not connect both the ANTENNA and the WIRE antennas at the same time.

5. Connect your ground connection to one of the GROUND posts.
6. Key your transceiver to output a carrier of 5-20 watts CW, FM or AM. Insure the tuner tuned to an SWR of 1.5:1 or better.
7. You are ready to transmit.

Note:

- When the tuner power is OFF, the tuner is in bypass mode and RF from the transmitter goes directly to the antenna with no matching. The tuner also powers up in the bypass mode.
- During the automatic tuning process, the tuner will make some noise. These are the relays switching at a very high rate, and it is normal. Do not be alarmed.

Installation

WARNING

- Never operate the tuner with its cover removed. Contact with the components inside the tuner while transmitting will result in painful RF burns.
- Locate the tuner so that the antenna terminals are not accessible during operation. The single wire connection will have high voltage while transmitting.
- Do not mount in a position that will put it under water at any time.
- Do not mount it in a place that will allow sprinklers or water hoses to spray the weather seals or connectors
- Always tune with low power (about 10 watts). Apply maximum power only after tuning up.
- Never exceed tuner specifications.
- Do not transmit with a high SWR for extended periods of time.

1. Mount the tuner in a convenient place to the antenna. Mount it in such a way that it will not come in contact with people, pets, or shrubbery. The Wire terminal will have high RF voltages on it in use. These voltages can cause serious RF burns if the terminals are touched when transmitting.
2. The tuner can be mounted vertical or with the plastic cover up. Do not mount with the cover face down. Water may accumulate and seep into the tuner. If mounted with the connectors toward the bottom then take the cover off and place it with the MFJ logo upright so any water that may get into the tuner will have a chance of draining out at the bottom of the cover.
3. Connect the tuner to the transceiver, the amplifier, and the antenna with 50-ohm coaxial cables capable of handling the RF power levels expected. See Figure 1 on page 4. 3. Connect the antenna(s) to the tuner as follows:
4. Random wire or single wire line antennas should be connected to the WIRE binding post on the back of the tuner. Note the back panel warning: Do not connect WIRE and ANTENNA at same time! Both are connected in parallel.

Note: Route all single and random wire antennas safely to prevent RF burn hazard. For balanced feedlines, connect an MFJ-912 1.5 kW 4:1 balun to the antenna connector output of the MFJ-998RT.

5. Several GROUND posts are provided for RF ground connections. See "Grounding Hints" on page 24.
6. Connect up the feed line between the transceiver or amplifier and the tuner to the TRANSMITTER connector on the tuner. The cable should be 50 ohm and heavy enough to handle the power of your radio or amplifier.
7. If optional Lightning Surge Suppressors are used in line with the feed line to the tuner make sure they are the type that will pass DC such as the MFJ-272. DC power is supplied down the feed line to the tuner.
8. The feed line from the tuner is connected to the MFJ-4117 BIAS TEE RF/DC connector.
9. Connect the MFJ-4117 BIAS TEE RF connector to the transceiver or amplifier if used.
10. Connect a 12-15V power supply to the DC input of the MFJ-4117 BIAS TEE to supply power to the tuner. The station supply or an MFJ-1316 will work. The supply needs to be capable of supplying 1.4A.
11. If an optional local antenna switch is used place it before the BIAS TEE (the RF side not the RF/DC side) to prevent the chance of shorting out the DC line with the switch.

Note: The MFJ-998RT is not designed to work with remote antenna switches. Some antennas and antenna switches have DC continuity between the center pin and shield which will short out the power supply when switched to those positions

Operation

1. Turn on the tuner power. With the power off the Tuner is in Bypass mode. With power on the unit wakes up in bypass mode till RF is supplied to the tuner.
2. Initial Tuneup:
 - a. Transmit a low power signal (5 to 20 watts, never with the amplifier in transmit mode).
 - b. Wait while the tuner finds a tuning solution for that frequency. Verify that the SWR is below the target SWR (default 1.5:1).
 - c. Once the tuner has found a tuning solution you are ready to operate at high power.
 - d. You can repeat the initial tune up on other frequencies and bands so the tuner will memorize what settings are needed for these frequencies and bands.
 - e. If the solution is higher than you prefer but within the SWR window of the retune functions turn off the tuner so it will go to bypass, turn it back on then after 2 seconds and try to tune again.
3. Normal Tuneup
 - a. Transmit a low power signal (5 to 20 watts, never with the amplifier in transmit mode).
 - b. The tuner will check the frequency and set the tuner for the settings for that frequency if memorized and quickly tune to those settings.
 - c. If the frequency is not memorized or the SWR is outside the tuning window then the tuner will retune as in the initial tuneup.
4. Once the tuner is tuned up you can switch to high power operation.
5. Manual tuning is possible but is not available remotely. To tune manually you will have to remove the cover and operate the controls as indicated in the section "MANUAL TUNING" on page 15. Once a manual setting is found it can be saved for later retrieval as in the above step 3.

WARNING

Never tune up with high power.

Always use low power (5 to 20 watts) when tuning up or changing frequencies. Tuning with high power will cause voltages and currents that may exceed the component ratings or present antenna loads that will damage an amplifier or radio during the tuning process.

WARNING:

Do not turn the power on and off rapidly, otherwise the tuner setting memory can be corrupted and the unit will have to be reset to factory defaults. Leave the tuner off for 1 to 2 seconds before turning it back on.

Note: When attempting to tune the Tuner will not tune and go into bypass when the forward power exceeds 75 watts and the SWR is greater than 3.0, or when the forward power exceeds 125 watts while tuning regardless of the SWR. See "Morse Code and Beeps" Page 16

Internal Controls

The internal control panel is used for testing and specialized setup and is not available for normal operation of the MFJ-998RT. The analog meter is not included in the remote tuner. The other functions are available only when the cover is removed for testing.

WARNING

Do not operate the tuner with high power when the cover is removed. Do not touch the components while testing. High RF Voltages are present even with low power testing.

Control Panel

- **LCD Display:** A 2-line by 16-character alphanumeric display. It displays the tuner's various menus and status. The display contrast can be adjusted by the LCD contrast control on the front panel. Below the display are the SWR and power bar meter scales. Refer to Figures 15 and 16 for descriptions of the various displayed information.
- **LCD Contrast Control:** A trimpot control that adjusts the contrast of the LCD display. Use a small flat blade screwdriver, insert into the CONTRAST control VR5 to the right of the display, and turn clockwise to increase contrast.
- **ANT Button:** Has two different functions based on the length of time you press and hold it before releasing. Press [ANT] quickly (less than one second) to select the antenna bank to tune. Press button to toggle between antenna banks 1 and 2. The Antenna indicator on the main display indicates the selected antenna bank. Press and hold [ANT] for one second to cycle among the four memory banks of the current antenna bank. The selected bank is indicated by a series of short beeps, where one beep indicates bank A, two beeps indicate bank B, three beeps indicate bank C, four beeps indicate bank D, and five beeps indicate antenna memory is OFF. The Memory indicator on the main display also indicates the selected bank. Pressing the [ANT] button switches the antenna bank or memory bank only when there is no RF power. Also, the tuner setting for the selected antenna bank or memory bank, if available, is instantly restored from memory when enabled.
- **MODE Button:** Time-sensitive and used to navigate through the various main menus and to enter or exit the setup menus.
- **C-UP and C-DN Buttons:** Used to manually increase or decrease the capacitance of the L-network matching circuit. The capacitance ranges are 0 to 3926 pF (picofarads) on the input side and 0 to 976 pF on the output side. The upper limit of capacitance, dependent on frequency, is used to limit the maximum voltage and current across the tuner's components. This limit can be removed in the LC Limit setup menu, but is not recommended.

Note: Pressing [C-UP] and [C-DN] simultaneously toggles the capacitor between the input and output sides of the L-network. One beep when the capacitor is on the antenna side. Two beeps when the capacitor is on the transmitter side.

- **L-UP and L-DN Buttons:** Used to manually increase or decrease the inductance of the L-network matching circuit. The inductance range is 0 to 24.28 μ H (microhenries). The upper limit of inductance, dependent on frequency, is used to limit the maximum voltage and current across the tuner's components. This limit can be removed in the LC Limit setup menu, but is not recommended.

Note: Pressing [C-DN] and [L-DN] (both DOWN buttons) simultaneously places the tuner in bypass mode. One beep sounds to indicate bypass mode. RF from the transmitter goes directly to the antenna with no matching.

- **TUNE Button:** Has three different functions based on the length of time you press and hold it before releasing. Press [TUNE] quickly (less than 0.5 second) to bypass the tuner. One beep indicates bypass mode, where RF from the transmitter goes directly to the antenna with no matching. A second quick press toggles the tuner back to its last L/C setting, and the tuner responds with two beeps.
- Press [TUNE] for 0.5 to 2 seconds to start the automatic tuning process. Tuning starts when [TUNE] is released after the 0.5-2 second hold-time. The transmitter must be keyed first with at least five watts of power. When the SWR is already below the target SWR, pressing [TUNE] will fine-tune the match for a lower SWR, if possible.

Note: You can reverse the two functions above by pressing and holding the [TUNE] button for approximately 10 seconds. I.e., when the [TUNE] button is pressed and held for 10 seconds. You will hear two beeps. Now pressing [TUNE] momentarily starts the tuning process, and pressing and holding the [TUNE] button for 0.5-2 seconds puts the tuner into the bypass mode.

- **Automatic/Semi-Automatic Tuning Mode**
Automatic Tune mode is the standard mode for the MFJ-998RT. Pressing [TUNE] and [ANT] simultaneously toggles between automatic and semi-automatic tuning mode. In automatic mode, the tuning routine is automatically started when at least five watts of power is applied and the SWR is a preset amount above the preset target SWR. In semi-automatic mode, the tuning routine starts only when the [TUNE] button is pressed for 0.5 to 2 seconds. The Auto/Semi indicator on the main display indicates the selected mode. Refer to Figures 15 and 16 for the on-screen Auto/Semi indicator.

Note: During the tuning process, the tuner will make some noise. These are the relays switching at a very high rate, and it is normal. Do not be alarmed.

- **POWER Button:** Used to turn the power on and off. The MFJ-998RT should normally be left in the ON position and switched remotely. When the power is off, the tuner is placed in bypass mode. When turning on the power, the tuner powers up in the bypass mode and displays the target SWR on the main screen.

Note: When remotely switching the power off and on leave the power off for at least 2 seconds so the power supply capacitors in the tuner completely discharge.

- The tuner requires 12 volts DC at up to 1.4 amps. The use of a regulated supply is not mandatory but is recommended for best performance. An optional 12 volts DC 1.5 amp power supply, the MFJ-1316, is available from MFJ Enterprises, Inc.

WARNING:

Do not apply voltages greater than 18 volts to this unit, or permanent damage to the unit may result.

Note: When the tuner power is OFF, the tuner is in bypass mode and RF from the transmitter goes directly to the antenna with no matching. When turned on, the tuner powers up in bypass mode.

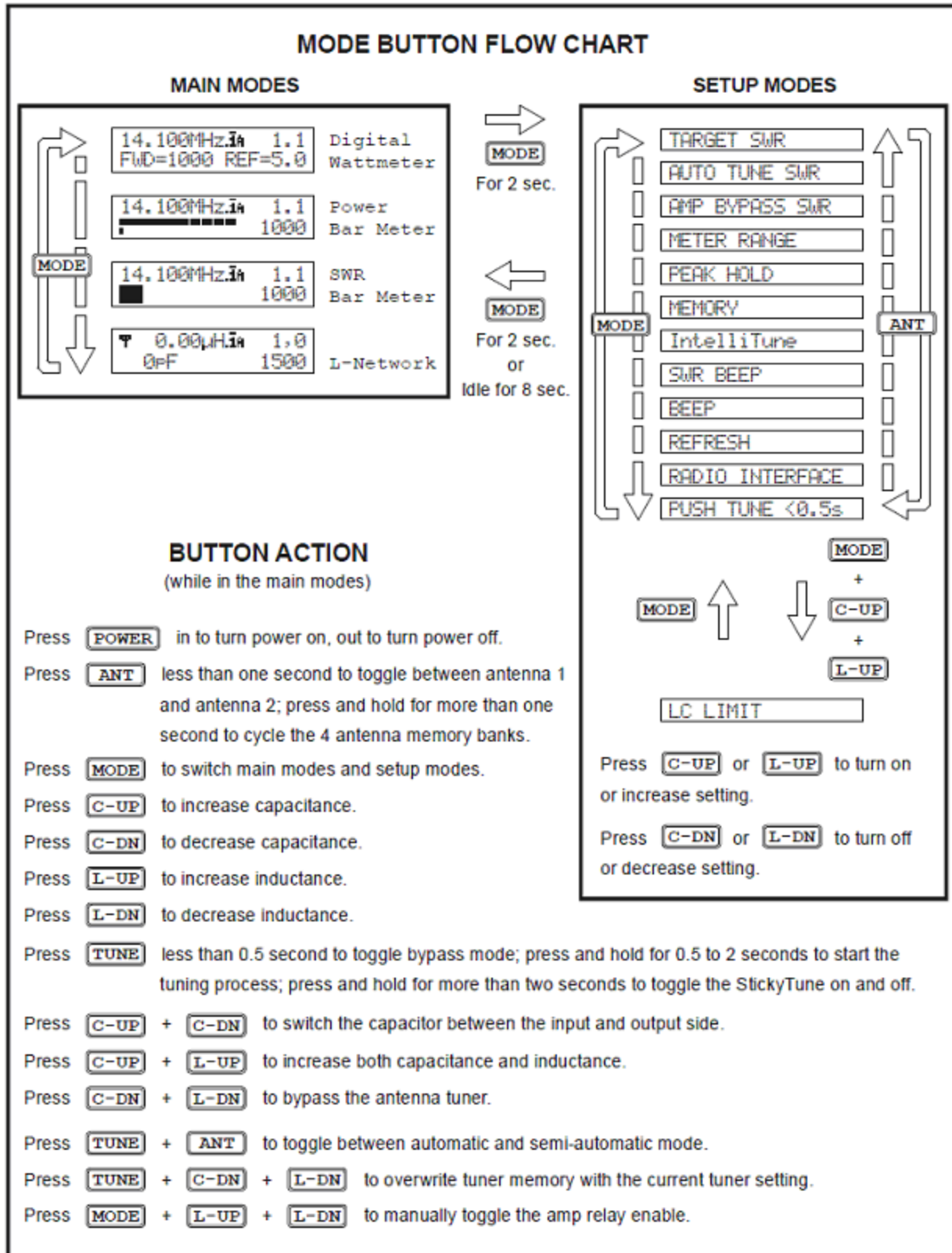

MODE ↑

↓ **MODE**

MODE +

↓ **C-UP**

+

↓ **L-UP**

+

LC LIMIT

Press **C-UP** or **L-UP** to turn on or increase setting.

Press **C-DN** or **L-DN** to turn off or decrease setting.

Figure 2 Mode Button Flow Chart

The Menus

Main Mode Menus

These instructions are for setup and testing and the functions are not available for normal operation of the MFJ-998RT. When accessing these settings and controls do not touch any of the components other than the switches because of the chance of high RF voltages when tuning. Do not leave the cover off for normal operation.

The main mode menus show various tuner settings and status. There are four main mode menus arranged in a “wrap-around” structure. When powered on, tuner operation starts with the main menu that was last used. Within each main menu, press the [MODE] button briefly to view the next main menu.

Press and hold the [MODE] button for two seconds to enter the setup mode (see below). Various tuner indicators are shown on all four main menus: Antenna banks 1/2, IntelliTune™, Radio Interface, Memory, LC Limit, Auto Range, Auto/Semi, and StickyTune™. Refer to Figures 6 and 7 for details on the displayed information.

Note:

- In sideband mode, the frequency readout on the tuner display jumps around to different frequencies while transmitting and stops on another frequency when un-keyed. This is normal and is a characteristic of sideband mode, because sideband signals jump up and down in frequency and power.
- In bypass mode, the decimal point in the SWR reading is replaced with a comma.

Digital Wattmeter Menu

Shows the frequency, SWR, and forward and reflected power in watts.

Power Bar Meter Menu

Shows the frequency, SWR, forward power, and bar meters for forward and reflected power. The top bar meter is the forward power and the bottom bar meter is the reflected power. The numeric reading of forward power appears at the end of the bar meters. Each power bar meter is consisted of 60 bar segments. When in the high power range, multiple the readings on the printed power scale by ten and each vertical bar segment consists of three dots. Below 1000 watts, each bar segment represents 20 watts; above 1000 watts, each bar segment represents 200 watts. The forward bar meter has a “peak hold” feature. The peak meter hold function freezes the highest displayed bar segment of the forward power for about one second, so that you can more easily read the meter. This function can be turned ON and OFF in the Peak Hold setup mode. For low-power tuning, meter range of 300 watts is available. When in the low power range, each vertical bar segment consists of two dots. Below 100 watts, each bar segment represents two watts; above 100 watts, each bar segment represents 20 watts. Refer to the “SWR/Wattmeter” section on page 13 for more details on power range. The power meter can be set to auto range. Auto range automatically sets the meter scale according to the input RF power to the tuner. Forward power greater than 300 watts or reflected power greater than 60 watts automatically sets the meter to the high power range. Forward power less than 250 watts and reflected power less than 40 watts automatically set the meter to the low power range. When auto range is on, a two-dot vertical segment appears on the on-screen tuner indicator. Refer to Figures 3 and 4 for the on-screen Auto Range indicator.

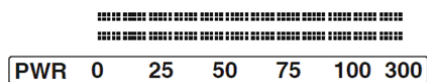

Figure 3 Low Power Forward and Reflected Bargraph

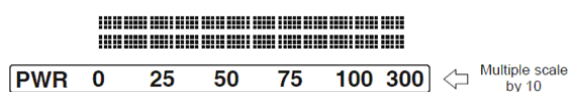

Figure 4 High Power Forward and Reflected Bargraph

The SWR Bargraph shows the frequency, SWR, forward power, and SWR bar meter. The 12-block (31-segment) SWR bar meter indicates SWR of 1.0, 1.1, 1.2, 1.3, 1.4, 1.5, 1.6-1.7, 1.8-2.0, 2.1-2.5, 2.6-3.0, 3.1-5.0, 5.1 to infinity. The numeric reading of forward power appears at the end of the bar meter. There is also an audio SWR indicator (see “SWR Beep Menu” section on page 14).

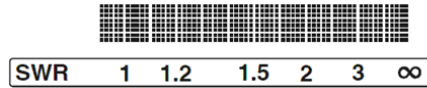

Figure 5 SWR Bargraph

L-Network Menu

Shows the configuration of the L-network matching circuit, SWR, and forward power. The antenna symbol, on the upper left corner, indicates the antenna side of the L-network. The capacitance value is displayed to the left when it is on the antenna side and to the right when it is on the transmitter side. Inductance value is shown in microhenries (μH) and capacitance value in picofarads (pF). The numeric reading of forward power appears at the lower right corner of the display. See “Manual Tuning” on page 14.

Tuner Indicators

Various tuner indicators are shown on the main menus to indicate tuner status. Refer to Figures 6 and 7 for locations of these indicators. The number enclosed within () is the item number of Figure 7.

- Antenna Bank: A small “1” appears to indicate antenna bank 1 is selected (15); a small “2” appears to indicate antenna bank 2 is selected (16).
- Radio Interface: One dot appears on the left side of the Antenna indicator to indicate the selected radio interface (17-21). Refer to Figure 7 below. The Radio Interface function is not used in this tuner.
- Amp Relay Enable: When Amp Relay Enable is OFF, a bar appears on top of the Antenna indicator (22). The Amp Relay function is not used in this tuner.
- Memory: A small “A”, “B”, “C” or “D” appears to indicator the selected memory bank when Memory is ON (23-26); nothing appears when Memory is OFF.
- LC Limit: When LC Limit is OFF, a bar appears on top of the Memory indicator (27).
- Auto Range: When Auto Range is ON, a two-dot vertical bar segment appears on the lower left corner of the Memory indicator (28).
- Auto/Semi: A small “S” appears to indicate semi-automatic mode (29); nothing appears to indicate automatic mode.
- *StickyTune*: When *StickyTune*™ is ON, a bar appears on top of the Auto/Semi indicator (30).

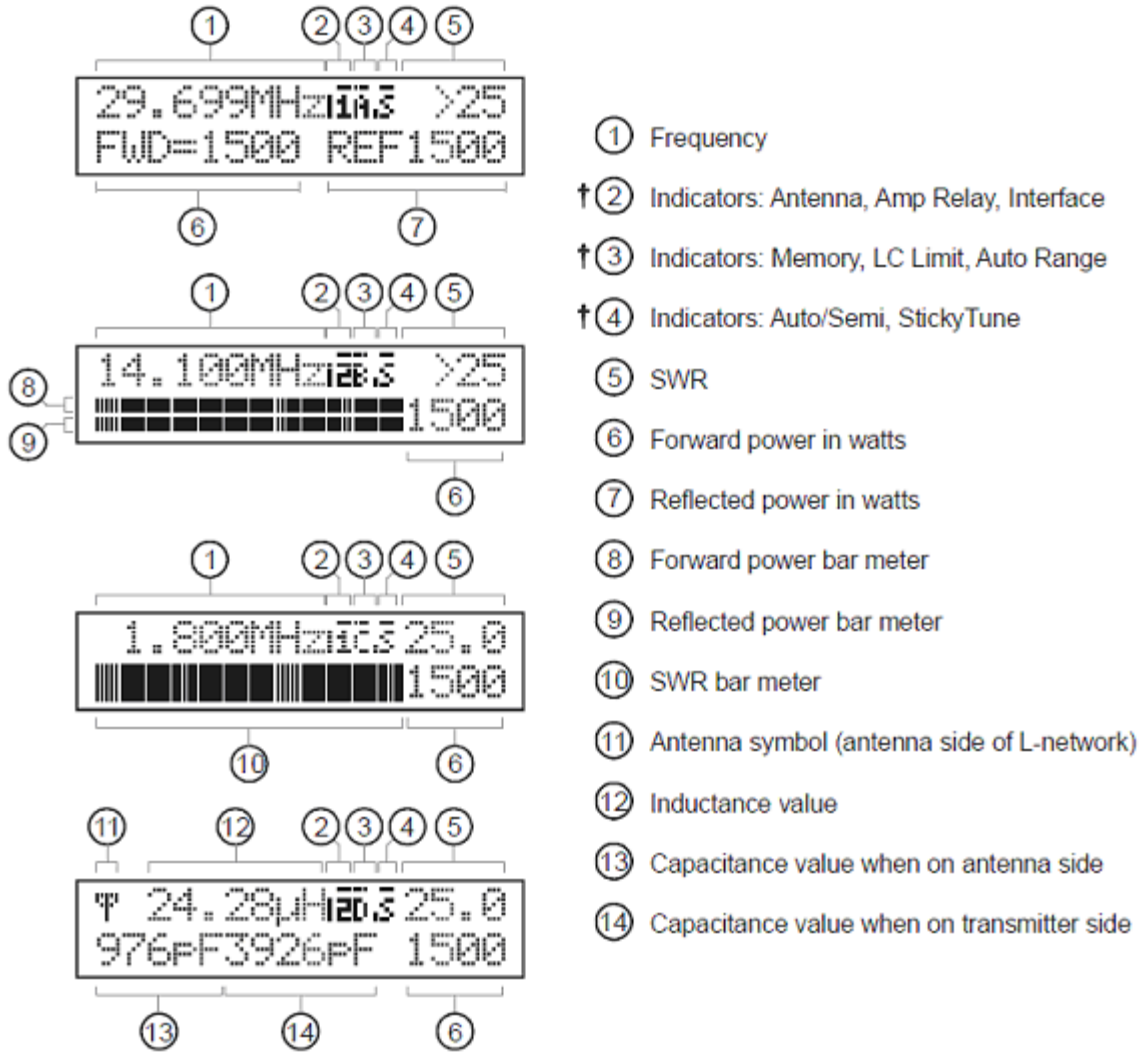

Figure 6 LCD Display

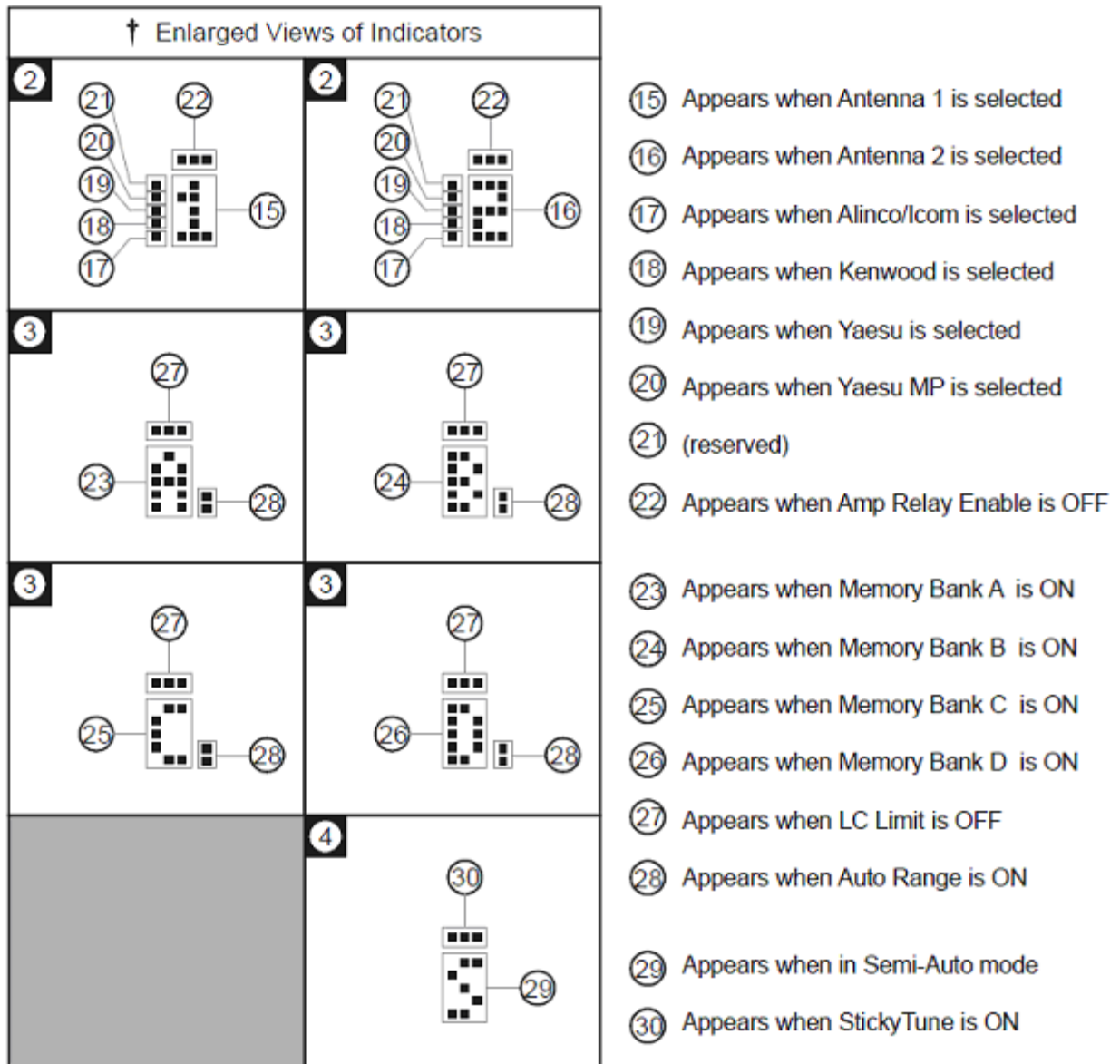

Figure 7 Display Tuner Indicators Enlarged

Setup Mode Menus

These instructions require removal of the cover to access. Do not touch the components inside the unit except for the switches. When testing high RF voltages may be present. Do not leave the cover off for normal operation.

The setup mode menus allow you to set up how the MFJ-998RT works and behaves. There are 13 setup mode menus arranged in a “wrap-around” structure. To access these setup menus, press and hold the [MODE] button for two seconds. The setup menu that will display is the one that was last used. When finished, press the [MODE] button for two seconds to go back to the main mode for normal operation. The tuner goes into protective bypass mode in the setup mode and restores the matching network after exiting the setup mode. If no button is pressed for more than eight seconds, the tuner automatically exits the setup mode, restores the matching network, and returns to the main mode. In addition, the following setup modes are stored separately for antenna banks 1 and 2: Target SWR, Auto Tune SWR, Amp Bypass SWR, Meter Range, Peak Hold, Memory, and IntelliTune™.

Within each setup menu:

- Press the [MODE] button briefly to cycle forward through the setup menus; press and hold the [MODE] button for two seconds to exit the setup mode and go back to the main mode.
- Press the [ANT] button to cycle backward through the setup menus.
- Press the [C-UP] or [L-UP] button to increase or turn on the setting for the current setup menu.
- Press the [C-DN] or [L-DN] button to decrease or turn off the setting for the current setup menu.

Target SWR Menu

Allows you to set the target SWR from 1.0 to 2.0. The tuning process will stop when a match with an SWR less than or equal to the target SWR is found. Setting the target SWR lower than 1.5 may require longer tuning times. The target SWR is shown on the initial display when the tuner is powered on. Default is 1.5.

Auto Tune SWR Menu

Allows you to set the SWR threshold in the range 0.5 to 1.5. In the automatic mode, the tuning process will automatically start when the SWR is above the target SWR by this amount of SWR threshold. For example, for target SWR of 1.5 and auto tune SWR of 1.0, the tuning process will start whenever the SWR is above 2.5 ($1.5 + 1.0$) and there is at least five watts of RF power. Default is 0.5.

Amp Bypass SWR Menu

Not available in the MFJ-998RT

Meter Range Menu

Not available in the MFJ-998RT

Peak Hold Menu

When the peak hold function is ON, the highest activated segment of the forward bar meter remains visible for about one second, so that you can more easily read it. When OFF, the meter functions normally. Default is ON.

Memory Menu

Turns the antenna memory on and off. The “memory resolution” is the width of frequency spectrum that the tuner recognizes as being the same as a tuned frequency already in memory. The memory resolution is approximately 0.1 percent of the lower frequency of each amateur band. For example, the memory resolution on the 40-meter band (7000 to 7300 kHz) is 7 kHz; if the tuner has memorized a setting for 7050 kHz, it will automatically call up this setting for any frequency from 7047 to 7053 kHz. Memory resolution is smaller at lower frequency to accommodate the higher antenna Q and larger at higher frequency where the antenna Q is lower. The memory resolutions for the HF amateur bands 160 through 10 meters are:

| Meter | Frequency Range (MHz) | Memory Resolution |
|-------|--|--------------------|
| 160 | 1.800-2.000 | 2 |
| 75/80 | 3.500-4.000 | 4 |
| 60 | 5.3305, 5.3465, 5.3665, 5.3715, and 5.4035 | 5 memory locations |
| 40 | 7.000-7.300 | 7 |
| 30 | 10.100-10.150 | 10 |
| 20 | 14.000-14.350 | 14 |
| 17 | 18.068-18.168 | 18 |
| 15 | 21.000-21.450 | 21 |
| 12 | 24.890-24.990 | 25 |
| 10 | 28.000-29.700 | 28 |

Figure 8 Tuning Window Resolution Chart

The memory resolution for non-amateur frequency bands between 160 and 10 meters is approximately 0.2 percent of the lower frequency of each band. There are over 2500 memory locations for each memory bank, and each antenna bank has four memory banks (A-D).

Tuner settings are stored in memory separately for Antenna bank 1 and Antenna bank 2. This provides memory for up to eight different antennas. Refer to Figures 15 and 16 for the on-screen Memory indicator. Defaults are memory banks 1A and 2A ON. To clear an antenna memory bank, select the antenna memory bank with the [ANT] button, turn off the power to the tuner, then press and hold both [TUNE] and [C-UP] buttons while turning on the power. A DELETE BANK message will appear. To clear the memory for an antenna (all four banks), select the antenna with the [ANT] button, turn off the power to the tuner, then press and hold both [TUNE] and [ANT] buttons while turning on the power. A DELETE ANTENNA message will appear. "Total Reset" erases both antenna memories and returns all tuner settings to their factory default states. To achieve this, turn power off, press and hold [TUNE], [C-UP] and [L-UP] buttons while turning on the power. A TOTAL RESET message will appear.

Note: Pressing [TUNE], [C-DN] and [L-DN] buttons simultaneously overwrites the tuner memory with the current tuner setting; settings with SWR greater than 3.0 will not be stored.

IntelliTune™ Menu

Turns the *IntelliTune™* tuning algorithm on and off. When the tuner cannot find an appropriate setting in its memory, it begins its calculation function. It measures the complex impedance of the antenna (load) at the transmitting frequency, then it calculates the L/C components needed for a match. Then it fine-tunes the component values. If for any reason the tuner cannot calculate the load impedance, it proceeds to yet another method of calculation. If for any reason, this function can be turned off. Default is ON.

SWR Beep Menu

Turns the audio SWR meter on and off. The audio meter is a series of beeps where one beep indicates SWR of 1.5 or less, two beeps indicate SWR of 1.6 to 2.0, three beeps indicate SWR of 2.1 to 2.5, and four beeps indicate SWR of 2.6 to 3.0. For SWR above 3.0, "SWR" (di-di-dit di-dah-dah di-dah-dit) will be sent on CW. This functions independent of the acknowledgement beep setting. Default is OFF.

Beep Menu

Acknowledgement beep sounds each time a parameter is changed to acknowledge it. This also controls the CW notification of "QRO", "QRP" and "QRT". This function can be turned OFF for silent operation, and this is independent of the SWR beep setting. Default is ON.

Refresh Menu

When the refresh function is ON, the display is updated while tuning is in progress. Because the display is not available for remote operation it is recommended that it is left off for quicker tuning. Default is OFF.

Radio Interface Menu

This function is not used in the Remote Tuner. **Leave this setting OFF.**

Auto/Semi-Automatic Mode

Semi-automatic operation is not available on the remote tuner. **Leave in AUTOMATIC mode.**

Pressing [TUNE] and [ANT] simultaneously toggles between automatic or semi-automatic tuning mode. In automatic mode, the tuning routine is automatically started when at least five watts of power is applied and the SWR is a preset amount above the preset target SWR. The Auto/Semi indicator on the main display indicates the selected mode.

LC Limit Menu

The upper limits of inductance (L) and capacitance (C) are factory-limited according to frequency and maximum power rating; i.e., higher frequencies need less inductance and less capacitance when the L-network is properly tuned. Pressing [C-UP] and/or [L-UP] allows capacitance and inductance to be increased only to these limits. When a selected capacitance or inductance is higher than its allowed limit, and the frequency is changed, that selection is automatically reduced to the value of its limit. These limits are used to prevent matching of extreme load impedance outside the tuner's specification, which may result in excess voltage and/or current across the tuner's components. This setting is not stored in nonvolatile memory and reverts back to the default when the tuner power is cycled. Refer to Figures 6 and 7 for the on-screen LC Limit indicator. If this feature is turned OFF, it will be re-set to ON whenever power is cycled. Default is ON.

WARNING:

LC Limit is a safety precaution; the tuner is in danger of being damaged if this function is turned off.

Setup Operation

Manual Tuning

Note: Manual tuning must only be attempted under low power (less than 20 watts) conditions.

In certain cases the operator may wish to "touch up" the tuner's settings. For example, if the target SWR is set at the default of 1.5, the tuner will stop when a match of 1.5 is found. Changing frequencies may raise the SWR but still be within the SWR retune window. Manual tuning gives the user control of the tuner if desired, and the L-Network menu provides a picture of the matching network configuration.

Manual tuning is accomplished by using the [C-UP], [C-DN], [L-UP], and [LDN] buttons. Since it is not known if more or less capacitance (or inductance) is needed, manual tuning must be by trial-and-error.

Press [C-UP] one time, and the reflected power will indicate if [C-UP] was the right "direction." If it was, press [C-UP] again and observe reflected power. If not, press [C-DN] twice (once to return to the original setting of C, and once for one click past it).

Manual tuning of inductance is similarly accomplished, using [L-UP] and [L-DN]. Since the capacitance and inductance are interdependent, some back-and-forth between the two may be needed, just as in a conventional tuner with knobs. Once you are familiar with this process, you will learn how to match certain antennas and frequencies.

Pressing [C-UP] and [C-DN] buttons simultaneously moves the capacitance back and forth from one side of the inductance to the other. The L-Network menu displays the capacitance on the left to indicate that the capacitance is on the antenna side (corresponding with the rear panel configuration of connectors); the capacitance value moves to the right side of the display when the capacitance is on the transmitter side of the inductance. A general rule of thumb is that loads with impedance higher than 50 ohms call for the capacitance on the antenna side; loads with impedance lower than 50 ohms call for the capacitance on the transmitter side.

Pressing [C-DN] and [L-DN] simultaneously or pressing [TUNE] quickly places the tuner in bypass mode; i.e. zero inductance and zero capacitance. RF from the transmitter goes directly to the antenna with no

matching. One beep indicates changing to bypass mode. Also, the decimal point in the SWR reading is replaced with a comma.

Pressing [TUNE], [C-DN] and [L-DN] simultaneously overwrites the tuner memory with the current tuner setting; settings with SWR greater than 3.0 will not be stored. One beep indicates memory overwrite.

Morse Code and Beeps

If not enough power is applied for tuning (less than five watts), the display will flash INCREASE POWER three times and “QRO” (dah-dah-di-dah di-dah-dit dah-dah-dah) will be sent on CW. Increasing the input power above five watts ends this message. When input power is too high, the tuner enters a self-protection mode. The tuner will not allow any of its relays to change. This feature is to prevent damage to your tuner.

If too much power is applied when tuning, the tuner will cease the tuning routine, flash DECREASE POWER three times and send “QRP” (dah-dah-di-dah di-dah-dit di-dah-dah-dit) on CW. This occurs when the forward power exceeds 75 watts and the SWR is greater than 3.0, or when the forward power exceeds 125 watts regardless of the SWR. If more than 1500 watts is applied to the tuner, the tuner will go into bypass mode, flash OVERLOAD three times and send “QRT” (dah-dah-di-dah di-dah-dit dah) on CW. If the tuning process is activated under these conditions, the tuner will not start the tuning. It will display a warning message on the LCD and send the appropriate code on CW. The following table shows the various tuner beeps:

| Function | Indicates By One Beep | | | Indicates By Two Beeps | | | By Pressing |
|--|-------------------------------|------------------------|------------------------|----------------------------|----------------------|--|---|
| Antenna Bank | 1 | | | 2 | | | [ANT] <1 second |
| Memory Bank | A 1 Beep | B 2 Beeps | C 3 Beeps | D 4 Beeps | OFF 5 Beeps | | [ANT] >1 second |
| Bypass Toggle | Bypass Mode (L=0 and C=0) | | | Restore Last L/C Setting | | | [TUNE] <0.5 seconds or [C-DN]+[L-DN] |
| Tuned SWR | SWR <1.5 1 Beep | SWR <2.0 2 Beeps | SWR <2.5 3 Beeps | SWR <3.0 4 Beeps | SWR >3.0 “SWR” | | [TUNE] for 0.5-2 seconds |
| StickyTune™ | ON | | | OFF | | | [TUNE] for 2-10 seconds |
| [TUNE]<0.5 sec. | To Bypass | | | To Tune | | | [TUNE] >10 seconds |
| Manual L/C Adjustment | L/C at Lower Limit | | | L/C at Upper Limit | | | [C-DN] or [L-DN] [C-UP] or [L-UP] |
| Capacitors | Switch to Antenna Side | | | Switch to Transmitter Side | | | [C-UP]+[C-DN] |
| Tuning Mode | Automatic | | | Semi-Automatic | | | [TUNE]+[ANT] |
| Memory Overwrite | X | | | | | | [TUNE]+[C-DN]+[L-DN] |
| Amplifier Bypass Control™ | ON | | | OFF | | | [MODE]+[L-UP]+[L-DN] |
| Disable Radio Interface | | | | X | | | [TUNE]+[MODE]+[POWER] |
| Delete Confirmation? DELETE BANK DELETE ANTENNA TOTAL RESET | Yes DELETED Or RESET | | | No CANCEL | | | [C-DN] for YES Or [L-DN] for NO |

Figure 9 Beep Indicators

Transceiver Foldback Circuit

Modern transceivers with solid-state finals usually have a foldback circuit to protect the final transistors from high SWR, which can damage or destroy them. A foldback circuit detects the SWR during transmit and reduces the output power as the SWR rises above a preset threshold, usually 2:1. The higher the SWR the lower the power is set to prevent damage. If your transceiver has a foldback circuit, you can simply key down and tune at any power level from 5 to 100 watts. If your transceiver does not have a foldback circuit, you must manually set the power level to 20 watts or less for tuning. At higher power levels, the reflected power occurred during tuning can damage your transceiver and causes component

arcing which can damage the relays in the tuner. Check your transceiver owner's manual to see if yours has a foldback circuit. The use of the AM mode normally will drop the radio to around 20 to 40 watts or so. This is a convenient way of reducing power and supplying a continuous carrier for tuneup.

Grounding Hints

To minimize RFI, single wire feedlines (such as used with true Windom or longwire antennas) should be kept away from other wiring. Radiation will be minimized if the single wire feeder runs parallel and reasonably close to the wire that connects the tuner to the outdoor ground. The antenna feed wire should be adequately insulated to prevent arcing or accidental contact.

CAUTION

For operator safety, a good outside earth ground or water pipe ground should always be installed and connected to the case of the MFJ-998RT. Make certain the safety ground also connects to the transmitter and other station accessories. A wing-nut post marked GROUND is provided for ground connections. For safety, please use good DC and RF grounds. It is particularly important to have a good RF ground when using a single wire feeder. When using a single wire feeder, the tuner needs something to "push" against in order to force current into the single wire feedline. If a good RF ground is not available, RF will usually find its way back into the power line (RFI), transmitter audio circuits (RF feedback), or the operator (RF burns). Metal underground water pipes and ground rods provide good DC and AC safety grounds, but they are often inadequate for RF grounding because they are single conductors. Ground rods by themselves are almost useless for dependable RF grounding. RF grounds work much better when "spread out" over a large area, especially when they employ multiple connections directly to the equipment ground point. Metal water pipes, heating ducts, and fences may work (especially if they are connected together with multiple wires), but the best RF grounds are radial systems or multi-wire counterpoises. Radials and counterpoises provide large, low resistance surfaces for RF energy. RF and lightning travel on the surface of conductors. Braided or woven conductors have high surface resistance to lightning and RF. Ground leads for RF and lightning should have wide smooth surfaces. Avoid the use of woven or braided conductors in RF and lightning grounds unless the lead needs to be flexible. There are a number of articles in the technical literature that can advise on how to properly ground the antenna system for both lightning and RF signals.

Antenna System Hints

Location

For the best performance, an end-fed longwire wire antenna should be at least one quarter-wavelength long at the operating frequency. Horizontal dipole antennas should be at least a half-wavelength long and located as high and clear as possible. While good RF grounds help the signal in almost any transmitting installation, it is extremely important to have good RF grounds with long wire or other Marconi-style antennas.

Matching Problems

Most matching problems occur when the antenna system presents an extremely high impedance to the tuner. When the antenna impedance is much lower than the feedline impedance, an odd wavelength feedline converts the low antenna impedance to a very high impedance at the tuner. A similar problem occurs if the antenna has an extremely high impedance and the transmission line is a multiple of a half-wavelength. The half-wavelength line repeats the very high antenna impedance at the tuner. Incorrect feedline and antenna lengths can make an otherwise perfect antenna system very difficult or impossible to tune. One example where this problem occurs is on 80 meters when an odd quarter-wave (60 to 70 feet) open wire line is used to feed a half-wave (100 to 140 feet) dipole. The odd quarter-wave line transforms the dipole's low impedance to over three thousand ohms at the tuner. This is because the mismatched feedline is an odd multiple of 1/4 wavelength long. The line inverts (or teeter-totters) the antenna impedance. A problem also occurs on 40 meters with this same antenna example. The feedline is now a multiple of a half-wave (60 to 70 feet) and connects to a full-wave high impedance antenna (100

to 140 feet). The halfwave line repeats the high antenna impedance at the tuner. The antenna system looks like several thousand ohms at the tuner on 40 meters. This places enormous strain on the tuner, since voltages can reach several thousand volts. This can cause component arcing and heating.

The following suggestions will reduce the difficulty in matching an antenna with a tuner:

- Never center feed a half-wave multi-band antenna with a high impedance feedline that is close to an odd multiple of a quarter-wave long.
- Never center feed a full-wave antenna with a feedline close to a multiple of a half-wave long.
- If this tuner will not "tune" a multi-band antenna, add or subtract 1/8 wave of feedline (for the band that won't tune) and try again.
- Never try to load a G5RV or center fed dipole on a band below the half-wave design frequency. If you want to operate an 80-meter antenna on 160 meters, feed either or both conductors as a longwire against the station ground.

To avoid problems matching or feeding any dipole antenna with high impedance open wire lines, keep the lines around these lengths. [The worst possible line lengths are shown in brackets]: 160 meters dipole: 35-60, 170-195 or 210-235 feet [Avoid 130, 260 ft] 80 meters dipole: 34-40, 90-102 or 160-172 feet [Avoid 66, 135, 190 ft] 40 meters dipole: 42-52, 73-83, 112-123 or 145-155 feet [Avoid 32, 64, 96, 128 ft] Some slight trimming or adding of feedline may be necessary to accommodate the higher bands.

WARNING

To avoid problems, a dipole antenna should be a full half-wave on the lowest band. On 160 meters, an 80 or 40 meters antenna fed the normal way will be extremely reactive, with only a few ohms of feedpoint resistance. Trying to load an 80 meters half-wave dipole (or shorter) antenna on 160 meters can be a disaster for both your signal and the tuner. The best way to operate 160 meters with an 80 or 40 meters antenna is to load either or both feedline wires (in parallel) as a longwire. The antenna will act like a "T" antenna worked against station ground.

Appendices

POWER-ON OPERATIONS

| POWER-ON OPERATIONS | | | |
|--|--------------------|---------|-------------------------------------|
| (Press and hold buttons while turning on the power.) | | | |
| Press and hold | TUNE | + POWER | to start the self test. |
| Press and hold | C-DN | + POWER | to test the relays. |
| Press and hold | L-DN | + POWER | to test the power-down circuitry. |
| Press and hold | TUNE + MODE | + POWER | to disable the radio interface. |
| Press and hold | TUNE + ANT | + POWER | to delete current antenna memory. |
| Press and hold | TUNE + C-UP | + POWER | to delete current memory bank. |
| Press and hold | TUNE + L-UP | + POWER | to reset factory defaults. |
| Press and hold | TUNE + C-UP + L-UP | + POWER | to perform total reset. |
| Press and hold | C-UP + C-DN | + POWER | to calibrate the wattmeter. |
| Press and hold | C-UP + L-UP | + POWER | to calibrate the SWR bridge. |
| Press and hold | C-DN + L-DN | + POWER | to calibrate the frequency counter. |

Figure 10 Power On Operations

Resetting the Tuner

Each time the tuner is powered off, the microprocessor saves all memories and configurations to nonvolatile memory ready to be used the next time the unit is turned on and transmit power is applied. If the tuner is not working properly, even on initial power on, try resetting to the factory defaults.

Factory Defaults

The unit is shipped with the following default settings:

- Main Menu Digital Wattmeter
- Setup Menu Target SWR
- Inductance 0 μ H
- Capacitance 0 pF
- Antenna 1
- Tuning Mode Automatic †
- Target SWR 1.5 †
- Auto Tune SWR 0.5 above target SWR †
- Amp Bypass SWR 2.0 †
- Meter Range Auto range †
- Peak Hold On †
- Memory Banks 1A and 2A on †
- IntelliTune On †
- SWR Beep Off
- Beep On
- Refresh Off
- Radio Interface Off
- Push Tune <0.5s To Bypass

† These settings are stored separately for antenna banks 1 and 2.

Factory Default Reset

To reset the tuner to these defaults:

1. Turn off the power to the tuner.
2. Press and hold both the [TUNE] and [L-UP] buttons while turning the power on.
3. Release the buttons when DEFAULTS RESET appears on the display.
4. Resume with normal operation.

Note: Resetting to factory defaults does not erase the antenna memories.

Note: If the MFJ-998RT is not behaving properly or acting erratic, try resetting the tuner to factory defaults.

Total Reset

To erase both antenna memories and reset to factory defaults, press and hold down the [TUNE], [C-UP] and [L-UP] buttons while turning the power on. A confirmation message TOTAL RESET will display. Press the YES [C-DN] button to delete both antenna memories and reset factory defaults (a progress bar and RESET will display), or press the NO [L-DN] button to cancel (CANCEL will display). Release the button to resume normal operation. Remember that both antenna memories will be lost!

Disable Radio Interface

The Radio Interface should not be turned on because there is no way to connect to the radio. If the radio interface is selected and the TURN ON RADIO message does not go away, disable the interface by pressing and holding both [TUNE] and [MODE] buttons while turning the power on. The tuner will respond with two beeps.

Delete Entire Antenna Memory

To delete an entire antenna memory (all four banks), select Antenna 1 or Antenna 2 with the [ANT] button that you want to delete. Turn off power to the tuner, and then press and hold both the [TUNE] and [ANT] buttons while turning the power back on. A confirmation message DELETE ANTENNA will display. Press the YES [C-DN] button to delete the antenna memory (a progress bar and DELETED will display), or press the NO [L-DN] button to cancel (CANCEL will display). Release the button to resume normal operation. Remember that the selected antenna memory will be lost!

Delete Antenna Memory Bank

To delete an antenna memory bank, select Antenna 1 or Antenna 2 and the antenna memory bank with the [ANT] button that you want to delete. Turn off power to the tuner, and then press and hold both the [TUNE] and [C-UP] buttons while turning the power back on. A confirmation message DELETE BANK will display. Press the YES [C-DN] button to delete the antenna memory (a progress bar and DELETED will display), or press the NO [L-DN] button to cancel (CANCEL will display). Release the button to resume normal operation. Remember that the selected antenna memory bank will be lost!

Self Test

A self-test routine will check the functions of the MFJ-998RT. This routine checks the display, the front panel buttons, the internal memory, the audio circuitry, and the power-down circuitry. During the self test, you may stop the test by turning off the unit; however, this should NOT be done during the memory test or the memory could be corrupted. The self-test can be completed in approximately 30 seconds. Note:

Performing the self-test will reset the unit to its factory default settings.

Here is the self-test procedure:

1. Turn off the power to the tuner.
2. Unplug the radio interface cable, if one is connected, from the tuner.
3. Press and hold only the [TUNE] button while turning the power on.
4. The test begins by displaying a copyright message and firmware version numbers, such as This is the test of the display. Release the [TUNE] button before the message completes.
5. You will be prompted to press each of the front-panel buttons.

6. The unit then tests its non-volatile memory. Notice this step will reset the unit to its factory default settings.
7. If the unit is okay, a repetitive message PASS will be displayed and sent as Morse code (di-dah-dahdit di-dah di-di-dit di-di-dit). If there is a problem, a failure message will be displayed and sent repetitively.
8. Once you have confirmed that the audio is okay, turn the unit off.
9. Turn the unit on again to test the power-down detection circuitry.
10. If the power-down detection circuitry is okay, a repetitive message PASS will be displayed and sent as Morse code (di-dah-dah-dit di-dah di-di-dit di-di-dit). If there is a problem, message PD FAIL will be displayed and sent as Morse code repetitively.
11. Turn the power off.

| Failure Message | Indicates |
|-----------------|--|
| ANT FAIL | [ANT] shorted or improperly connected. |
| MODE FAIL | [MODE] shorted or improperly connected. |
| C-UP FAIL | [C-UP] shorted or improperly connected. |
| C-DN FAIL | [C-DN] shorted or improperly connected. |
| L-UP FAIL | [L-UP] shorted or improperly connected. |
| L-DN FAIL | [L-DN] shorted or improperly connected. |
| TUNE FAIL | [TUNE] shorted or improperly connected. |
| MEMORY FAIL | Non-volatile memory circuitry is improperly connected. |
| WAKEUP FAIL | Microprocessor wakeup circuitry problem. |
| PD FAIL | Power-down circuitry problem. |

Figure 11 Failure Messages

Power-Down Circuit Test

When the 12 VDC power to the tuner is turned off, the tuner saves all settings to non-volatile memory. The Power-Down Circuit Test checks the power down detection circuitry. It is recommended that this test be done immediately after the regular self-test described above.

Note: The tuner must be reset to factory defaults before performing this test.

Power-Down test procedure:

1. Make sure power to the tuner is off.
2. If the tuner has been reset to factory defaults, skip to step 6; otherwise continue with step 3.
3. Press and hold both the [TUNE] and [L-UP] buttons while turning the power on.
4. Release the buttons when DEFAULTS RESET appears on the display.
5. Turn the power off.
6. Press and hold only the [L-DN] button while turning the power on.
7. If the power-down detection circuitry is okay, a repetitive message PASS will be displayed and sent as Morse code (di-dah-dah-dit di-dah di-di-dit di-di-dit). If there is a problem, message PD FAIL will be displayed and sent as Morse code repetitively.
8. Turn the power off.

Relay Test

WARNING:

Turn off the transmitter power or disconnect the transmitter before performing this test; otherwise, damage to the tuner can result.

To test the relays and their control circuitry, press and hold the [C-DN] button while turning the power on. The message RELAY TEST will appear. Six numbers representing the relays will be shown on the display. The [ANT], [C-UP], [L-UP], [MODE], [C-DN] and [L-DN] buttons, corresponding to the position of the relay numbers on the display, are used to toggle each relay on and off. Press button to engage the relay and release it to disengage the relay. Listen for relay clicks. Press the [TUNE] button to proceed to the next group of six relays. There are 31 relays in the tuner. Repeat the above procedure to test all the relays. Normal operation is resumed after this test. Relays K2 and K31 are not included on the board so there will be no click on those relays.

SWR Bridge Calibration

To calibrate the SWR Bridge, you will need a transmitter capable of 100 watts output, a precise calibrated wattmeter, a 50-ohm dummy load, three 50-ohm SO-239 coax cables, a Phillips screwdriver, and a tuning tool or small flat blade screwdriver. **WARNING:** Do not touch anything inside the tuner during operation! Serious, painful RF burns can result.

1. Turn off the power to the tuner and the transmitter.
2. Remove the cover from the tuner (12 screws) with a Phillips screwdriver.
3. Connect the 50-ohm dummy load to the ANTENNA 1 connector; connect the watTMeter between the transmitter and the TRANSMITTER connector on the tuner.
4. Turn on the power to the transmitter. Using a frequency in the middle of the HF band, such as 7.253 MHz, for calibration is recommended.
5. Press and hold both the [C-UP] and [L-UP] buttons while turning the tuner power on.
6. A message CAL CAP AND FWD will display. Key the transmitter to output 100 watts and adjust trimmer capacitor VC1 (located on the small circuit board mounted in front of the TRANSMITTER connector) for minimum reflected power. Notice the reflected meter movement is exaggerated for easier calibration.
7. Key the transmitter to 100 watts output and adjust the FWD trimpot VR1 (located next to the big integrated circuit) until the display shows forward power of FWD=100 watts. The forward meter also should indicate 100 watts.
8. Press the [TUNE] button. A message REVERSE, CAL REF displays and the reflected meter goes to full scale.
9. Turn off the transmitter and reverse the ANTENNA 1 and TRANSMITTER connections; that is, connect the 50-ohm dummy load to the TRANSMITTER connector and connect the transmitter/watTMeter to the ANTENNA 1 connector.
10. Turn on the transmitter's power.
11. Key the transmitter to 100 watts output and adjust the REF trimpot VR2 (located next to the big integrated circuit) until the display shows reflected power of REF=100 watts. The forward meter (yes, the forward meter) also should indicate 100 watts; the reflected meter is at full scale.
12. Press the [TUNE] button to end calibration.
13. Turn off the power to the tuner and the transmitter.
14. Remove the transmitter/watTMeter and the 50-ohm dummy load from the tuner.
15. Secure the cover back onto the tuner.
16. Connect your transmitter to the TRANSMITTER connector and connect your antenna to the appropriate antenna connector on the tuner.

Frequency Counter Calibration

To calibrate the frequency counter, you will need a transmitter, a 50-ohm dummy load, two 50-ohm SO-239 coax cables, a Phillips screwdriver, and a tuning tool or small flat blade screwdriver.

WARNING:

Do not touch anything inside the tuner during operation! Serious, painful RF burns can result.

1. Turn off the power to the transmitter and the tuner.
2. Remove the cover from the tuner (16 screws) with a Phillips screwdriver.
3. Connect the 50-ohm dummy load to the COAX connector; connect the transmitter to the
1. TRANSMITTER connector on the tuner.
4. Turn on the power to the transmitter. Set and lock the frequency to exactly 29.000 MHz.
5. Press and hold both the [C-DN] and [L-DN] buttons while turning the tuner power on. Both meter needles will go to full scale and a message CAL FREQ 29.000 will display.
6. Key the transmitter to output about 10 watts. Adjust trimmer capacitor VC2 (located next to the big integrated circuit) until the tuner displays a frequency of 29.000MHz and the meter needles settle at the 0-watt marks. Notice the meter movement is exaggerated for easier calibration. Nominal tolerance of the frequency counter is ± 1 kHz.
7. Turn off the power to the transmitter and the tuner.
8. Secure the cover back onto the tuner.

List of Accessories

- MFJ-912: 1.5 kW 4:1 balun
- MFJ-1316: 12 VDC 1.5 amp power supply
- MFJ-5409: 6 feet long RS-232 cable, female DB-9 to male DB9 connector
- MFJ-5803: 3 feet long RG-58 A/U 50-ohm coax cable with a PL-259 connector on each end
- MFJ-5806: 6 feet long RG-58 A/U 50-ohm coax cable with a PL-259 connector on each end
- MFJ-5818: 18 feet long RG-58 A/U 50-ohm coax cable with a PL-259 connector on each end

FULL 12-MONTH WARRANTY

MFJ Enterprises, Inc. warrants to the original owner of this product, if manufactured by MFJ Enterprises, Inc. and purchased from an authorized dealer or directly from MFJ Enterprises, Inc. to be free from defects in material and workmanship for a period of 12 months from date of purchase provided the following terms of this warranty are satisfied.

1. The purchaser must retain the dated proof-of-purchase (bill of sale, canceled check, credit card or money order receipt, etc.) describing the product to establish the validity of the warranty claim and submit the original or machine reproduction of such proof of purchase to MFJ Enterprises, Inc. at the time of warranty service. MFJ Enterprises, Inc. shall have the discretion to deny warranty without dated proof-of-purchase. Any evidence of alteration, erasure, or forgery shall be cause to void any and all warranty terms immediately.
2. MFJ Enterprises, Inc. agrees to repair or replace at MFJ's option without charge to the original owner any defective product provided the product is returned postage prepaid to MFJ Enterprises, Inc. with a personal check, cashiers check, or money order for **\$12.00** covering postage and handling.
3. MFJ Enterprises, Inc. will supply replacement parts free of charge for any MFJ product under warranty upon request. A dated proof of purchase and a **\$8.00** personal check, cashiers check, or money order must be provided to cover postage and handling.
4. This warranty is **NOT** void for owners who attempt to repair defective units. Technical consultation is available by calling (662) 323-5869.
5. This warranty does not apply to kits sold by or manufactured by MFJ Enterprises, Inc.
6. Wired and tested PC board products are covered by this warranty provided **only the wired and tested PC board product is returned**. Wired and tested PC boards installed in the owner's cabinet or connected to switches, jacks, or cables, etc. sent to MFJ Enterprises, Inc. will be returned at the owner's expense un-repaired.
7. Under no circumstances is MFJ Enterprises, Inc. liable for consequential damages to person or property by the use of any MFJ products.
8. **Out-of-Warranty Service:** MFJ Enterprises, Inc. will repair any out-of-warranty product provided the unit is shipped prepaid. All repaired units will be shipped COD to the owner. Repair charges will be added to the COD fee unless other arrangements are made.
9. This warranty is given in lieu of any other warranty expressed or implied.
10. MFJ Enterprises, Inc. reserves the right to make changes or improvements in design or manufacture without incurring any obligation to install such changes upon any of the products previously manufactured.
11. All MFJ products to be serviced in-warranty or out-of-warranty should be addressed to **MFJ Enterprises, Inc., 300 Industrial Park Rd, Starkville, Mississippi 39759, USA** and must be accompanied by a letter describing the problem in detail along with a copy of your dated proof-of-purchase and a telephone number.
12. This warranty gives you specific rights, and you may also have other rights, which vary from state to state.

Rev 04/08/2011

MFJ-998RT Manual
Version 1A

Printed In U.S.A. 09/2011

MFJ ENTERPRISES, INC
300 Industrial Park Road
Starkville, MS 39759